

CONCEPT LINE Platino GUEST BATHROOM 2.0 - model list

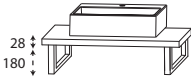

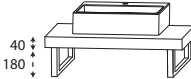
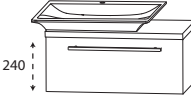
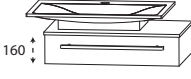
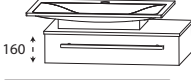

Additional units and accessories - see separate chapter

Depth indication corresponds to the carcass depth	Depth in mm	Width in mm	Height in mm	Article number	Hinge	Surcharge high-gloss carcass
 <p>Consisting of: Ceramic counter top washbasin Piccolo 390 mm width incl. not lockable flow-off valve washbasin plate with ABS edge 2 towel holder console in chrome</p> <p>Additional accessories Design installationsset chrome:</p>	395	612	328	S E T F G 6 0 1 0 P Z 1 3 8 9 1 E		
 <p>washbasin top in solid oak</p> <p>Consisting of: Ceramic counter top washbasin Piccolo 390 mm width incl. not lockable flow-off valve washbasin plate in oak solid 2 towel holder console in chrome</p> <p>Additional accessories Design installationsset chrome:</p>	400	612	340	S E T F G 6 0 0 9 P Z 1 3 8 9 1 E		
 <p>Ill. = right</p> <p>Consisting of: Washbasin base unit 600 mm 1 metal pull out unit with buffered closing 1 top cover with ABS edge Ceramic counter top washbasin Olinda incl. not lockable flow-off valve</p> <p>Additional accessories Design installationsset chrome:</p>	365	653	338	S E T F G 6 0 0 8 P Z 1 3 8 9 1 E	L/R	
 <p>Ill. = right</p> <p>Consisting of: Washbasin base unit 600 mm 1 metal pull out unit with buffered closing cast mineral - topcover washbasin Portofino white incl. not lockable flow-off valve 1 glass plate in optiwhite with depth 152 mm</p> <p>Additional accessories Design installationsset chrome:</p>	410	666	255	S E T F G 6 0 0 2 P Z 1 3 8 9 1 E	L/R	
 <p>Ill. = right</p> <p>Consisting of: Washbasin base unit 600 mm 1 metal pull out unit with buffered closing cast mineral - topcover washbasin Portofino white incl. not lockable flow-off valve 1 top cover Qsolid Surface polished</p> <p>please indicate colour version</p> <p>Additional accessories Design installationsset chrome:</p>	410	666	257	S E T F G 6 0 P 2 P Z 1 3 8 9 1 E	L/R	

Please observe the product details of the accessories in the separate index.

CONCEPT LINE Platino GUEST BATHROOM 2.0 - model list

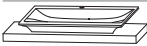





Additional units and accessories - see separate chapter

	Depth in mm	Width in mm	Height in mm	Article number	Hinge	Surchar- ge high- gloss carcass
Depth indication corresponds to the carcass depth						
Ceramic counter top washbasin						
				Ceramic counter top washbasin Orlando white incl. not lockable flow-off valve trailing edge not glazed		
	360	510	120	W T A 5 1 3 6 1		
				Ceramic counter top washbasin Piccolo white incl. not lockable flow-off valve trailing edge not glazed		
	300	390	120	W T A 3 0 3 9 1		
				Ceramic counter top washbasin Olinda white incl. not lockable flow-off valve trailing edge not glazed		
	365	500	70	W T A 1 1 0 6 1		
Cast mineral washbasins						
				counter top washbasin Portofino, white incl. not lockable flow-off valve		
	365	500	85	A W M 1 0 5 0 1		
STONEPLUS-fitting washbasin						
 STONEPLUS				STONEPLUS fitting washbasin Straight Position in the plate 30 mm to the wall white without overflow incl. CLOU drain and overflow system in chrome For a washbasin base unit with a 160 mm high drawer at the top, washbasin only possible in combi- nation with a 60 mm high washbasin top possible		
	330	512	20	W M S 2 3 0 5 6 1		

Please observe the product details of the accessories in the separate index.

CONCEPT LINE Platino GUEST BATHROOM 2.0 - model list

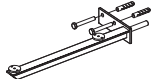
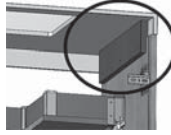



Additional units and accessories - see separate chapter

Depth indication corresponds to the carcass depth		Depth in mm	Width in mm	Height in mm	Article number	Hinge	Surcharge high-gloss carcass
 <p>Qsolid washbasin plate, to be fixed on washbasin base units price per metre</p> <p>4 mm have to be added at both sides. (left/right)</p>  <p>only in combination with washbasin base units and base units for washbasin plates</p> <p>Optional top modification: Return left Return right</p>		400	600-2980	12	WP S 4 1 V P O		
 <p>Qsolid washbasin plate self-supporting or surface mounted price per metre</p> <p>4 mm have to be added at both sides. (left/right)</p>  <p>Concealed mounting possible</p> <p>Unsupported plate with the console PZ 1244 40: We recommend ordering 2 brackets from 600 mm, 3 from 1006 mm and from 1650 mm to order 4 brackets in addition.</p> <p>Overlying plate with the spacer PZ DZAG 20: Application examples see page Pt. 23</p>		400	600-2980	60	WP S 4 V O P O		
 <p>Console for washbasin tops 60 mm high gris</p> <p>Price per item</p> <p>for the wall attachment of free hanging washstand tops</p>		330	150	50	P Z 1 2 4 4 4 0	L/R	
 <p>Distance compensation for surface-mounted washbasin plate Qsolid 60 mm</p> <p>Price per item</p>		20	21	69	P Z D Z A G 2 0		
 <p>Porcelain ceramic washbasin plate, to be fixed on washbasin base units price per metre</p> <p>4 mm have to be added at both sides. (left/right)</p> <p>only in combination with washbasin base units and base units for washbasin plates</p>		400	600-2980	22	WP P 4 2 V		

If planning with wall taps, this needs to be indicated separately in the order.

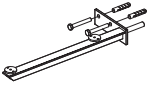
CONCEPT LINE Platino GUEST BATHROOM 2.0 - model list

Additional units and accessories - see separate chapter

	Depth in mm	Width in mm	Height in mm	Article number	Hinge	Surcharge high-gloss carcass
Depth indication corresponds to the carcass depth						
Washbasin plates reduced depth						
	400	600-2200	60	WP 4 V V M F O		
<p>washbasin plate self-supporting or surface mounted price per metre in front surface thermo coated 4 mm have to be added at both sides. (left/right)</p> <p>Unsupported plate with the console PZ 1244 40: We recommend ordering 2 brackets from 600 mm, 3 from 1006 mm and from 1650 mm to order 4 brackets in addition.</p> <p>2 concealed fastenings possible as standard Info & application example see page Pt. 22 & 23 If required, please order additional cutouts for the brackets for the consoles!</p> <p>Optional top modification: Surcharge additional milling for the console</p>				A U S T K 4 0 6 0		
	330	150	50	P Z 1 2 4 4 4 0	L/R	
<p>Console for washbasin tops 60 mm high gris Price per item for the wall attachment of free hanging washstand tops</p>						
 in oak solid	400	612-1612	40	W P M 4 0 V O A		
<p>washbasin plate self-supporting or surface mounted price per metre in no. 103 solid oak 6 mm have to be added at both sides - left/right</p> <p>Cantilever slab with the L-console or the towel holder console: We recommend ordering 2 brackets from 600 mm and 3 brackets from 1000 mm brackets to be ordered in addition.</p> <p>No cut-out possible for other manufactures</p>						
	400	600-2600	28	A P N 4 0 V 2 8		
<p>washbasin plate self-supporting or surface mounted price per metre in carcass colour with ABS edge 4 mm have to be added at both sides. (left/right)</p> <p>Cantilever slab with the L-console or the towel holder console: We recommend ordering 2 brackets from 600 mm and 3 brackets from 1000 mm brackets to be ordered in addition.</p> <p>Optional top modification: Return left Return right</p>				A P N 6 0 R S L A P N 6 0 R S R		
	320	30	180	P Z 1 1 1 8 4 0		
<p>L-Console for washbasin tops Price per item for the wall attachment of free hanging washstand tops</p> <p>in chrome</p> <p>in black matt</p>				320 30 180 320 30 180		
	373	30	180	P Z 1 1 3 3 4 0		
<p>Towel holder console Price per item for the wall attachment of free hanging washstand tops</p> <p>in chrome</p> <p>in black matt</p>				373 30 180 373 30 180		

If planning with wall taps, this needs to be indicated separately in the order.

CONCEPT LINE Platino GUEST BATHROOM 2.0 - model list

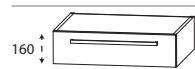
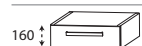

Additional units and accessories - see separate chapter

Depth indication corresponds to the carcass depth	Depth in mm	Width in mm	Height in mm	Article number	Hinge	Surcharge high-gloss carcass
Washbasin plates reduced depth						
<p>cut- out for washbasins of other manufactures Orders can only be accepted with dimensioned drawings.</p> <p>for Qsolid washbasin tops</p> <p>for washbasin tops in front finishes:</p> <p>for washbasin tops in carcass colour</p> <p>for porcelain ceramic washbasin tops</p> <p>price per cutout</p>				<p>A U S K D</p> <p>A U S K D 6 0</p> <p>A U S K D 2 8</p> <p>A U S K D 2 2</p>		
Base units reduced depth height 160 mm						
 <p>Washbasin base unit 1 drawer with buffered closing with metal traverse syphon cut- out central,</p> <p>600 mm wide</p> <p>700 mm wide</p> <p>800 mm wide</p> <p>900 mm wide</p> <p>Additional accessories Design installationsset chrome: Additional price for offset the syphon cutout / without cutout</p>	<p>375</p> <p>375</p> <p>375</p> <p>375</p>	<p>600</p> <p>700</p> <p>800</p> <p>900</p>	<p>160</p> <p>160</p> <p>160</p> <p>160</p>	<p>W U P 1 1 6 0 0 6</p> <p>W U P 1 1 7 0 0 6</p> <p>W U P 1 1 8 0 0 6</p> <p>W U P 1 1 9 0 0 6</p> <p>P Z 1 3 8 9 1 E</p>		
 <p>washbasin base unit 1 drawer with buffered closing</p> <p>300 mm width</p> <p>400 mm wide</p> <p>500 mm width</p> <p>600 mm wide</p> <p>700 mm wide</p> <p>800 mm wide</p> <p>900 mm wide</p>	<p>375</p> <p>375</p> <p>375</p> <p>375</p> <p>375</p> <p>375</p> <p>375</p>	<p>300</p> <p>400</p> <p>500</p> <p>600</p> <p>700</p> <p>800</p> <p>900</p>	<p>160</p> <p>160</p> <p>160</p> <p>160</p> <p>160</p> <p>160</p> <p>160</p>	<p>U T A 1 1 3 0 P 6</p> <p>U T A 1 1 4 0 P 6</p> <p>U T A 1 1 5 0 P 6</p> <p>U T A 1 1 6 0 P 6</p> <p>U T A 1 1 7 0 P 6</p> <p>U T A 1 1 8 0 P 6</p> <p>U T A 1 1 9 0 P 6</p>		

*Price per Washbasin base unit. Please attach a sketch to your order. Check your order confirmation of correctness.

CONCEPT LINE Platino GUEST BATHROOM 2.0 - model list

Additional units and accessories - see separate chapter

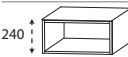
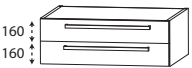
Depth indication corresponds to the carcass depth		Depth in mm	Width in mm	Height in mm	Article number	Hinge	Surchar- ge high- gloss carcass
Base units reduced depth height 240 mm							
 <p>240 ↑ ↓ 240</p>	Washbasin base unit 1 metal pull-out with buffered closing, with metal traverse						
	600 mm wide	375	600	240	WUP 1 2 6 0 0 6		
	700 mm wide	375	700	240	WUP 1 2 7 0 0 6		
	800 mm wide	375	800	240	WUP 1 2 8 0 0 6		
	900 mm wide	375	900	240	WUP 1 2 9 0 0 6		
	Additional accessories socket element Space-saving drain stench trap DN 40 Space-saving drain stench trap DN 32				P Z 1 0 9 5 P Z 1 3 6 7 P Z 1 4 2 3		
 <p>240 ↑ ↓ 240</p>	washbasin base unit 1 metal pull-out with buffered closing incl. drawer rail						
	300 mm wide	375	300	240	UTA 1 2 3 0 P 6		
	400 mm wide	375	400	240	UTA 1 2 4 0 P 6		
	500 mm wide	375	500	240	UTA 1 2 5 0 P 6		
	600 mm wide	375	600	240	UTA 1 2 6 0 P 6		
	700 mm wide	375	700	240	UTA 1 2 7 0 P 6		
	800 mm wide	375	800	240	UTA 1 2 8 0 P 6		
	900 mm wide	375	900	240	UTA 1 2 9 0 P 6		
 <p>240 ↑ ↓ 240</p>	Shelf in carcass colour adjustable in depth und width Cannot be used in the vicinity of the attachment console for the top.	150-300	150-600	240	RV 2 0 V 0 1		
		301-470	150-600	240	RV 2 0 V T 1		
Base units reduced depth height 320 mm							
 <p>160 ↑ ↓ 160</p>	Washbasin base unit 2 metal pull-outs with buffered closing, with metal traverse syphon cut- out central,						
	600 mm wide	375	600	320	WUP 2 2 6 0 0 6		
	700 mm wide	375	700	320	WUP 2 2 7 0 0 6		
	800 mm wide	375	800	320	WUP 2 2 8 0 0 6		
	900 mm wide	375	900	320	WUP 2 2 9 0 0 6		
	Additional accessories Space-saving drain stench trap DN 40 Space-saving drain stench trap DN 32 Additional price for offset the syphon cutout / without cutout				P Z 1 3 6 7 P Z 1 4 2 3		

*Price per Washbasin base unit. Please attach a sketch to your order. Check your order confirmation of correctness.

CONCEPT LINE Platino GUEST BATHROOM 2.0 - model list

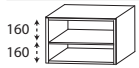
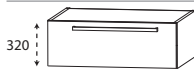

Additional units and accessories - see separate chapter

Depth indication corresponds to the carcass depth		Depth in mm	Width in mm	Height in mm	Article number	Hinge	Surcharge high-gloss carcass
Base units reduced depth height 320 mm							
	washbasin base unit 2 metal pull-outs with buffered closing, from 300 mm depth, drawers 260 mm deep from 340 mm depth drawers 300 mm deep						
	300 mm wide depth adjustable	375 300-469	300 300	320 320	UTA 2 2 3 0 P 6 UTA 2 2 3 0 P V		
	400 mm wide depth adjustable	375 300-469	400 400	320 320	UTA 2 2 4 0 P 6 UTA 2 2 4 0 P V		
	500 mm wide depth adjustable	375 300-469	500 500	320 320	UTA 2 2 5 0 P 6 UTA 2 2 5 0 P V		
	600 mm wide depth adjustable	375 300-469	600 600	320 320	UTA 2 2 6 0 P 6 UTA 2 2 6 0 P V		
	700 mm wide depth adjustable	375 300-469	700 700	320 320	UTA 2 2 7 0 P 6 UTA 2 2 7 0 P V		
	800 mm wide depth adjustable	375 300-469	800 800	320 320	UTA 2 2 8 0 P 6 UTA 2 2 8 0 P V		
	900 mm wide depth adjustable	375 300-469	900 900	320 320	UTA 2 2 9 0 P 6 UTA 2 2 9 0 P V		
	Shelf 1 fixed shelf in carcass colour	150-300 301-470	150-600 150-600	320 320	R V 2 1 V 0 1 R V 2 1 V T 1		
	adjustable in depth und width Cannot be used in the vicinity of the attachment console for the top.						
	Washbasin base unit 1 metal pull-out with buffered closing, with metal traverse						
	600 mm wide	375	600	320	WUP 2 1 6 0 0 6		
	700 mm wide	375	700	320	WUP 2 1 7 0 0 6		
	800 mm wide	375	800	320	WUP 2 1 8 0 0 6		
	900 mm wide	375	900	320	WUP 2 1 9 0 0 6		
Additional accessories socket element Space-saving drain stench trap DN 40 Space-saving drain stench trap DN 32				P Z 1 0 9 5 P Z 1 3 6 7 P Z 1 4 2 3			

*Price per Washbasin base unit. Please attach a sketch to your order. Check your order confirmation of correctness.

CONCEPT LINE Platino GUEST BATHROOM 2.0 - model list

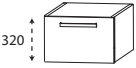
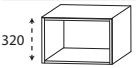
Additional units and accessories - see separate chapter

Depth indication corresponds to the carcass depth		Depth in mm	Width in mm	Height in mm	Article number	Hinge	Surcharge high-gloss carcass
Base units reduced depth height 320 mm							
	washbasin base unit 1 metal pull-out with buffered closing incl. drawer rail from 300 mm depth, drawers 260 mm deep from 340 mm depth, drawers 300 mm deep						
	300 mm wide depth adjustable	375 300-469	300 300	320 320	UTA 2 1 3 0 P 6 UTA 2 1 3 0 P V		
	400 mm wide depth adjustable	375 300-469	400 400	320 320	UTA 2 1 4 0 P 6 UTA 2 1 4 0 P V		
	500 mm wide depth adjustable	375 300-469	500 500	320 320	UTA 2 1 5 0 P 6 UTA 2 1 5 0 P V		
	600 mm wide depth adjustable	375 300-469	600 600	320 320	UTA 2 1 6 0 P 6 UTA 2 1 6 0 P V		
	700 mm wide depth adjustable	375 300-469	700 700	320 320	UTA 2 1 7 0 P 6 UTA 2 1 7 0 P V		
	800 mm wide depth adjustable	375 300-469	800 800	320 320	UTA 2 1 8 0 P 6 UTA 2 1 8 0 P V		
	900 mm wide depth adjustable	375 300-469	900 900	320 320	UTA 2 1 9 0 P 6 UTA 2 1 9 0 P V		
	Shelf in carcass colour adjustable in depth und width Cannot be used in the vicinity of the attachment console for the top.	150-300 301-470	150-600 150-600	320 320	RV 2 1 V 0 2 RV 2 1 V T 2		
	Base units reduced depth height 480 mm						
	Washbasin base unit 1 drawer with buffered closing with metal traverse syphon cut- out central, 1 metal pull-out with buffered closing incl. drawer rail						
	600 mm wide	375	600	480	WUP 3 2 6 0 0 6		
	700 mm wide	375	700	480	WUP 3 2 7 0 0 6		
	800 mm wide	375	800	480	WUP 3 2 8 0 0 6		
	900 mm wide	375	900	480	WUP 3 2 9 0 0 6		
Additional accessories socket element Space-saving drain stench trap DN 40 Space-saving drain stench trap DN 32 Additional price for offset the syphon cutout / without cutout					P Z 1 0 9 5 P Z 1 3 6 7 P Z 1 4 2 3		

*Price per Washbasin base unit. Please attach a sketch to your order. Check your order confirmation of correctness.

CONCEPT LINE Platino GUEST BATHROOM 2.0 - model list

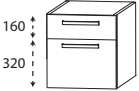
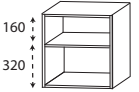
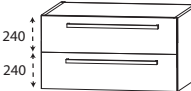

Additional units and accessories - see separate chapter

Depth indication corresponds to the carcass depth		Depth in mm	Width in mm	Height in mm	Article number	Hinge	Surcharge high-gloss carcass
Base units reduced depth height 480 mm							
	washbasin base unit 1 drawer with buffered closing 1 metal pull-out with buffered closing from 300 mm depth, drawers 260 mm deep from 340 mm depth, drawers 300 mm deep						
	300 mm wide	375	300	480	UTA 3 2 3 0 P 6		
	depth adjustable	300-469	300	480	UTA 3 2 3 0 P V		
	400 mm wide	375	400	480	UTA 3 2 4 0 P 6		
	depth adjustable	300-469	400	480	UTA 3 2 4 0 P V		
	500 mm wide	375	500	480	UTA 3 2 5 0 P 6		
	depth adjustable	300-469	500	480	UTA 3 2 5 0 P V		
	600 mm wide	375	600	480	UTA 3 2 6 0 P 6		
	depth adjustable	300-469	600	480	UTA 3 2 6 0 P V		
700 mm wide	375	700	480	UTA 3 2 7 0 P 6			
depth adjustable	300-469	700	480	UTA 3 2 7 0 P V			
800 mm wide	375	800	480	UTA 3 2 8 0 P 6			
depth adjustable	300-469	800	480	UTA 3 2 8 0 P V			
900 mm wide	375	900	480	UTA 3 2 9 0 P 6			
depth adjustable	300-469	900	480	UTA 3 2 9 0 P V			
	Shelf 1 fixed shelf in carcass colour	150-300	150-600	480	RV 3 1 V 0 2		
	adjustable in depth und width	301-470	150-600	480	RV 3 1 V T 2		
Cannot be used in the vicinity of the attachment console for the top.							
	Washbasin base unit 1 metal pull-out with buffered closing syphon cut- out central, 1 metal pull-out with buffered closing incl. drawer rail						
	600 mm wide	375	600	480	WUP 3 3 6 0 0 6		
	700 mm wide	375	700	480	WUP 3 3 7 0 0 6		
	800 mm wide	375	800	480	WUP 3 3 8 0 0 6		
	900 mm wide	375	900	480	WUP 3 3 9 0 0 6		
Additional accessories							
socket element					PZ 1 0 9 5		
Space-saving drain stench trap DN 40					PZ 1 3 6 7		
Space-saving drain stench trap DN 32					PZ 1 4 2 3		
Additional price for offset the syphon cutout / without cutout							

*Price per Washbasin base unit. Please attach a sketch to your order. Check your order confirmation of correctness.

CONCEPT LINE Platino GUEST BATHROOM 2.0 - model list

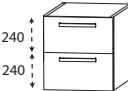
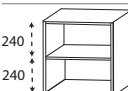
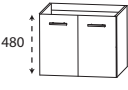
Additional units and accessories - see separate chapter

Depth indication corresponds to the carcass depth		Depth in mm	Width in mm	Height in mm	Article number	Hinge	Surcharge high-gloss carcass
Base units reduced depth height 480 mm							
	washbasin base unit 2 metal pull-outs with buffered closing from 300 mm depth, drawers 260 mm deep from 340 mm depth, drawers 300 mm deep	375	300	480	UTA 3 3 3 0 P 6		
	300 mm width depth adjustable	300-469	300	480	UTA 3 3 3 0 P V		
	400 mm wide depth adjustable	300-469	400	480	UTA 3 3 4 0 P 6 UTA 3 3 4 0 P V		
	500 mm width depth adjustable	300-469	500	480	UTA 3 3 5 0 P 6 UTA 3 3 5 0 P V		
	600 mm wide depth adjustable	300-469	600	480	UTA 3 3 6 0 P 6 UTA 3 3 6 0 P V		
	700 mm wide depth adjustable	300-469	700	480	UTA 3 3 7 0 P 6 UTA 3 3 7 0 P V		
	800 mm wide depth adjustable	300-469	800	480	UTA 3 3 8 0 P 6 UTA 3 3 8 0 P V		
	900 mm wide depth adjustable	300-469	900	480	UTA 3 3 9 0 P 6 UTA 3 3 9 0 P V		
	Shelf 1 fixed shelf in carcass colour	150-300	150-600	480	RV 3 1 V 0 1		
	adjustable in depth und width Cannot be used in the vicinity of the attachment console for the top.	301-470	150-600	480	RV 3 1 V T 1		
	Washbasin base unit 2 doors depth adjustable	200-470	600	480	WUA 3 1 6 0 1 V		
	600 mm wide 800 mm wide	200-470	800	480	WUA 3 1 8 0 1 V		
	washbasin base unit 1 door depth adjustable	200-470	300	480	UTA 3 1 3 0 1 V	L/R	
	300 mm width 400 mm wide	200-470	400	480	UTA 3 1 4 0 1 V	L/R	

CONCEPT LINE Platino GUEST BATHROOM 2.0 - model list

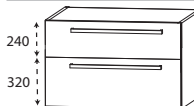
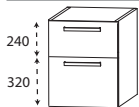
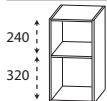

Additional units and accessories - see separate chapter

Depth indication corresponds to the carcass depth		Depth in mm	Width in mm	Height in mm	Article number	Hinge	Surcharge high-gloss carcass
Base units reduced depth height 560 mm							
	Washbasin base unit 1 metal pull-out with buffered closing syphon cut- out central, 1 metal pull-out with buffered closing incl. drawer rail						
	600 mm wide	375	600	560	WUP 4 2 6 0 0 6		
	700 mm wide	375	700	560	WUP 4 2 7 0 0 6		
	800 mm wide	375	800	560	WUP 4 2 8 0 0 6		
	900 mm wide	375	900	560	WUP 4 2 9 0 0 6		
Additional accessories socket element Space-saving drain stench trap DN 40 Space-saving drain stench trap DN 32 Additional price for offset the syphon cutout / without cutout					PZ 1 0 9 5 PZ 1 3 6 7 PZ 1 4 2 3		
	washbasin base unit 2 metal pull-outs with buffered closing from 300 mm depth, drawers 260 mm deep from 340 mm depth, drawers 300 mm deep						
	300 mm width	375	300	560	UTA 4 2 3 0 P 6		
	depth adjustable	300-469	300	560	UTA 4 2 3 0 P V		
	400 mm wide	375	400	560	UTA 4 2 4 0 P 6		
	depth adjustable	300-469	400	560	UTA 4 2 4 0 P V		
	500 mm width	375	500	560	UTA 4 2 5 0 P 6		
	depth adjustable	300-469	500	560	UTA 4 2 5 0 P V		
	600 mm wide	375	600	560	UTA 4 2 6 0 P 6		
	depth adjustable	300-469	600	560	UTA 4 2 6 0 P V		
	700 mm wide	375	700	560	UTA 4 2 7 0 P 6		
	depth adjustable	300-469	700	560	UTA 4 2 7 0 P V		
	800 mm wide	375	800	560	UTA 4 2 8 0 P 6		
	depth adjustable	300-469	800	560	UTA 4 2 8 0 P V		
900 mm wide	375	900	560	UTA 4 2 9 0 P 6			
depth adjustable	300-469	900	560	UTA 4 2 9 0 P V			
	Shelf 1 fixed shelf in carcass colour	150-300	150-600	560	RV 4 3 V 0 1		
		301-470	150-600	560	RV 4 3 V T 1		
adjustable in depth und width							
Cannot be used in the vicinity of the attachment console for the top.							

*Price per Washbasin base unit. Please attach a sketch to your order. Check your order confirmation of correctness.

CONCEPT LINE Platino GUEST BATHROOM 2.0 - model list

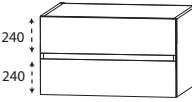
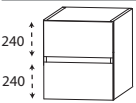
Additional units and accessories - see separate chapter

	Depth in mm	Width in mm	Height in mm	Article number	Hinge	Surcharge high-gloss carcass
Depth indication corresponds to the carcass depth						
Base units handleless reduced depth height 520 mm						
 <p>Washbasin base unit 1 metal pull-out with buffered closing syphon cut- out central, 1 metal pull-out with buffered closing incl. drawer rail</p>	600 mm wide	375	600	520	WUP 3 3 6 0 G 6	
	700 mm wide	375	700	520	WUP 3 3 7 0 G 6	
	800 mm wide	375	800	520	WUP 3 3 8 0 G 6	
	900 mm wide	375	900	520	WUP 3 3 9 0 G 6	
	Additional accessories					
					P Z 1 0 9 5	
					P Z 1 3 6 7	
					P Z 1 4 2 3	
	Additional price for offset the syphon cutout / without cutout					
 <p>washbasin base unit 2 metal pull-outs with buffered closing from 300 mm depth, drawers 260 mm deep from 340 mm depth, drawers 300 mm deep</p>	300 mm wide	375	300	520	UTA 3 3 3 0 G 6	
	depth adjustable	300-469	300	520	UTA 3 3 3 0 G V	
	400 mm wide	375	400	520	UTA 3 3 4 0 G 6	
	depth adjustable	300-469	400	520	UTA 3 3 4 0 G V	
	500 mm wide	375	500	520	UTA 3 3 5 0 G 6	
	depth adjustable	300-469	500	520	UTA 3 3 5 0 G V	
	600 mm wide	375	600	520	UTA 3 3 6 0 G 6	
	depth adjustable	300-469	600	520	UTA 3 3 6 0 G V	
	700 mm wide	375	700	520	UTA 3 3 7 0 G 6	
	depth adjustable	300-469	700	520	UTA 3 3 7 0 G V	
	800 mm wide	375	800	520	UTA 3 3 8 0 G 6	
	depth adjustable	300-469	800	520	UTA 3 3 8 0 G V	
	900 mm wide	375	900	520	UTA 3 3 9 0 G 6	
	depth adjustable	300-469	900	520	UTA 3 3 9 0 G V	
 <p>Shelf 1 fixed shelf in carcass colour</p>	150-300	150-300	520	RV 3 3 V 0 1		
	301-470	150-600	520	RV 3 3 V T 1		
	adjustable in depth und width					
Cannot be used in the vicinity of the attachment console for the top.						

*Price per Washbasin base unit. Please attach a sketch to your order. Check your order confirmation of correctness.

CONCEPT LINE Platino GUEST BATHROOM 2.0 - model list

Additional units and accessories - see separate chapter

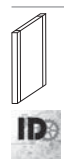
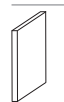
Depth indication corresponds to the carcass depth	Depth in mm	Width in mm	Height in mm	Article number	Hinge	Surcharge high-gloss carcass																																			
Side doublings with metall section for washbasin, & plate-base-units																																									
	<p>side doubling with metall section metal section for washbasin base units and base units for washbasin plates in black matt with 1 carcass-panel</p> <p>Please state the carcass colour</p> <p>Price per item</p> <table border="0" data-bbox="383 750 1332 828"> <tr> <td>for 320 mm high washbasin, & plate-base-units</td> <td>395</td> <td>19</td> <td>320</td> <td>SDH393202</td> <td></td> <td></td> </tr> <tr> <td>for 480 mm high washbasin, & plate-base-units</td> <td>395</td> <td>19</td> <td>480</td> <td>SDH394802</td> <td></td> <td></td> </tr> </table> <p>Please add 20 mm per side doubling for the extension to the washbasin.</p>						for 320 mm high washbasin, & plate-base-units	395	19	320	SDH393202			for 480 mm high washbasin, & plate-base-units	395	19	480	SDH394802																							
for 320 mm high washbasin, & plate-base-units	395	19	320	SDH393202																																					
for 480 mm high washbasin, & plate-base-units	395	19	480	SDH394802																																					
Side doublings with ABS edge for washbasin, & plate-base-units																																									
	<p>side doubling with ABS edge in carcass colour</p> <p>Price per item</p> <table border="0" data-bbox="383 1153 1332 1355"> <tr> <td>for 240 mm high washbasin, & plate-base-units</td> <td>395</td> <td>28</td> <td>240</td> <td>SWA392428</td> <td></td> <td></td> </tr> <tr> <td>for 320 mm high washbasin, & plate-base-units</td> <td>395</td> <td>28</td> <td>320</td> <td>SWA393228</td> <td></td> <td></td> </tr> <tr> <td>for 480 mm high washbasin, & plate-base-units</td> <td>395</td> <td>28</td> <td>480</td> <td>SWA394828</td> <td></td> <td></td> </tr> <tr> <td>for 520 mm high washbasin, & plate-base-units</td> <td>395</td> <td>28</td> <td>520</td> <td>SWA395228</td> <td></td> <td></td> </tr> <tr> <td>for 560 mm high washbasin, & plate-base-units</td> <td>395</td> <td>28</td> <td>560</td> <td>SWA395628</td> <td></td> <td></td> </tr> </table> <p>Please add 30 mm per side doubling for the extension to the washbasin.</p>						for 240 mm high washbasin, & plate-base-units	395	28	240	SWA392428			for 320 mm high washbasin, & plate-base-units	395	28	320	SWA393228			for 480 mm high washbasin, & plate-base-units	395	28	480	SWA394828			for 520 mm high washbasin, & plate-base-units	395	28	520	SWA395228			for 560 mm high washbasin, & plate-base-units	395	28	560	SWA395628		
for 240 mm high washbasin, & plate-base-units	395	28	240	SWA392428																																					
for 320 mm high washbasin, & plate-base-units	395	28	320	SWA393228																																					
for 480 mm high washbasin, & plate-base-units	395	28	480	SWA394828																																					
for 520 mm high washbasin, & plate-base-units	395	28	520	SWA395228																																					
for 560 mm high washbasin, & plate-base-units	395	28	560	SWA395628																																					

CONCEPT LINE Platino 2.0 - dimensional drawings

WMS 2305 61 (Straight)

WTA 5136 1 (Orlando)

SET FG60 09/10
WTA 3039 1 (Piccolo)

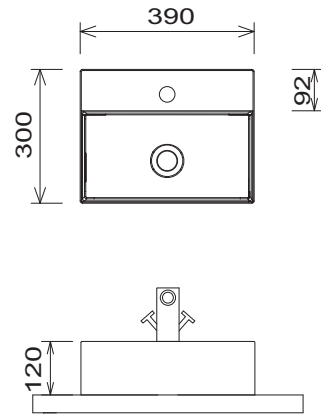
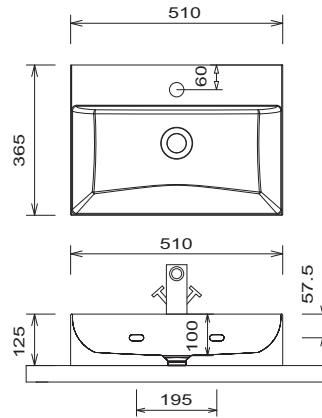
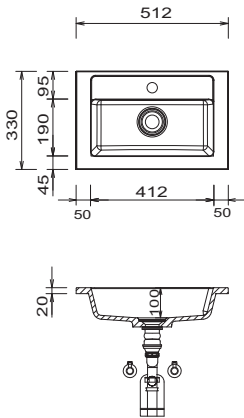

SET FG60 08
WTA 1106 1 (Olinda)

SET FG60 02/P2
AWM 1050 1 (Portofino)

ASSEMBLY EXAMPLE
SET FG60 10

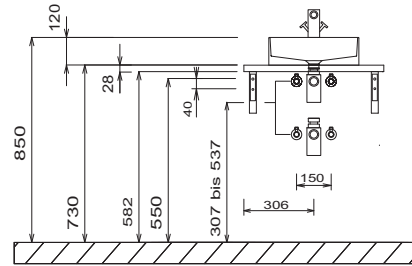
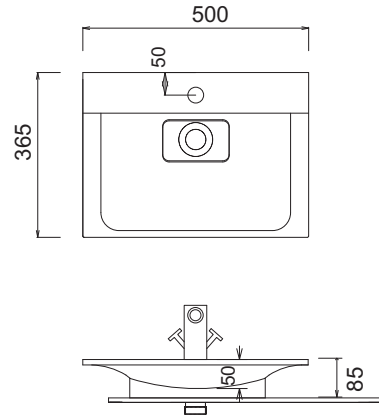
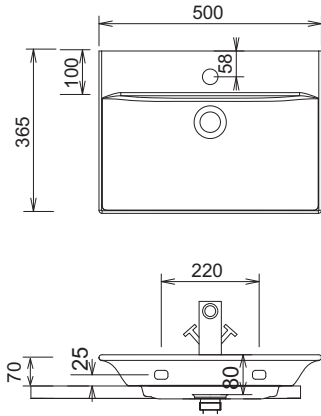

SET FG60 10
SET FG60 09

SET FG60 08
WTA 1106 1 (Olinda)

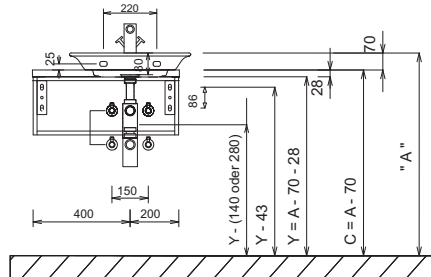
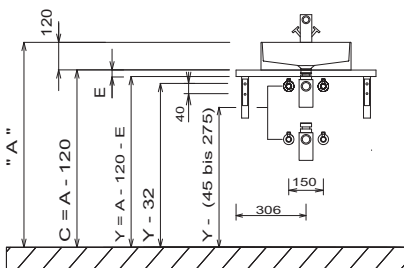

Modifications:
Technical modifications (+/- 5mm) and flatness modifications (DIN 18202) are subject of the usual material-specific modifications for construction materials, based on DIN 18202.

LEGEND

B = Width of Washbasin base units
A = Top of the washbasin
D = Washbasin installation height
E = Thickness of washbasin plate
C = Top of washbasin plate
Y = Top of the base unit
X = Position wastewater connection

CONCEPT LINE Platino 2.0 - dimensional drawings

SET FG60 02/P2
AWM 1050 1 (Portofino)

Washbasin base unit
height 160 mm & height 240 mm

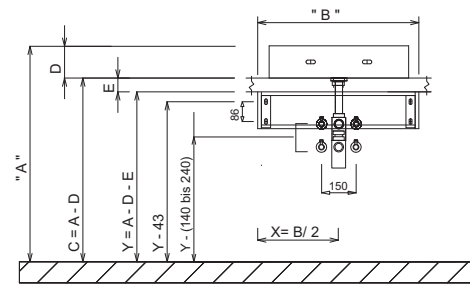
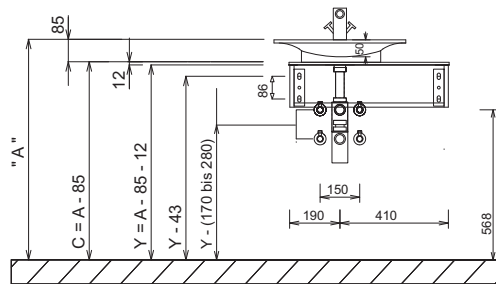

Washbasin base unit
height 320 mm

Washbasin base unit
height 480 mm, 520 mm & 560 mm

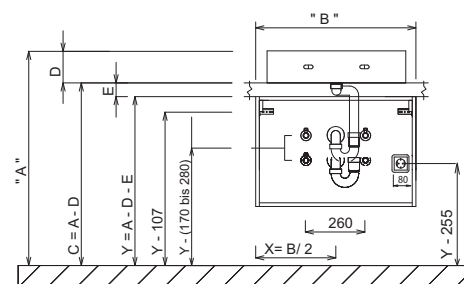
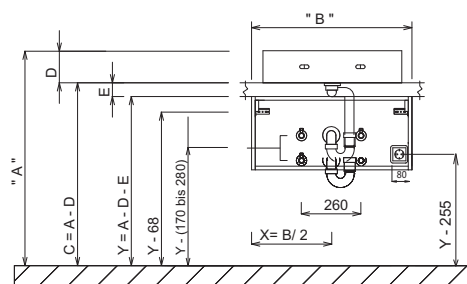

Base units for washbasin plates

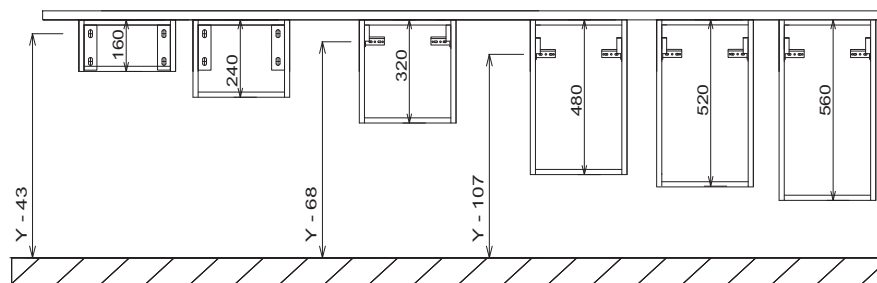

LEGEND
 B = Width of Washbasin base units
 A = Top of the washbasin
 D = Washbasin installation height
 E = Thickness of washbasin plate
 C = Top of washbasin plate
 Y = Top of the base unit
 X = Position wastewater connection

Modifications:
 Technical modifications (+/- 5mm) and flatness modifications (DIN 18202) are subject of the usual material-specific modifications for construction materials, based on DIN 18202.

CONCEPT LINE Platino 2.0 - dimensional drawings

Console for washbasin tops
PZ 1244 50/40

Console for washbasin tops
PZ 1244 50/40

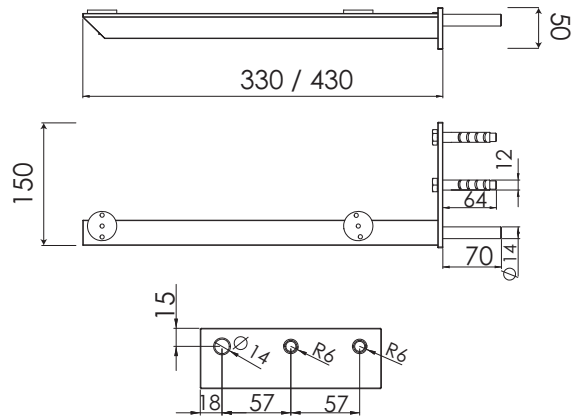
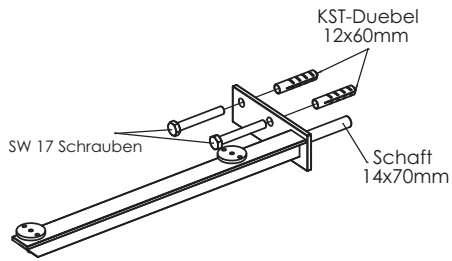

Towel holder console
PZ 1133 49/40 & PZ 1233 49/40

Towel holder console
PZ 1133 49/40 & PZ 1233 49/40

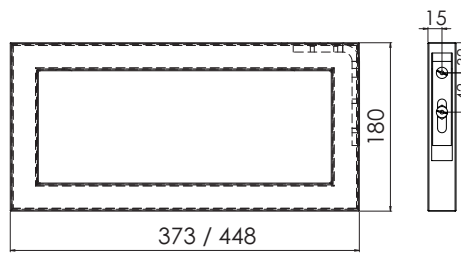
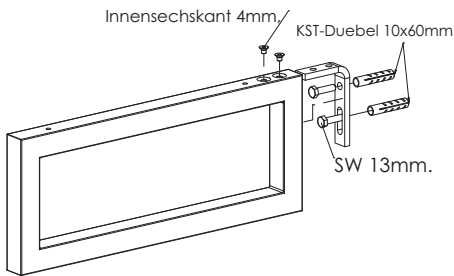

L-Console for washbasin tops
PZ 1118 49/40 & PZ 1218 49/40

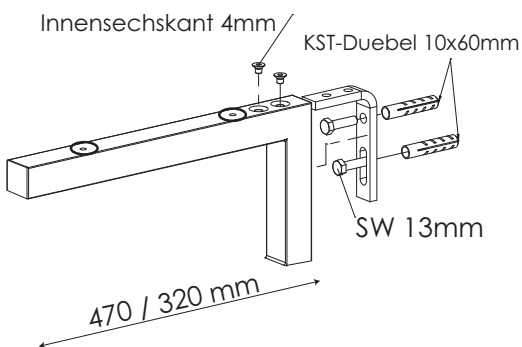

Modifications:
Technical modifications (+/- 5mm) and flatness modifications (DIN 18202) are subject of the usual material-specific modifications for construction materials, based on DIN 18202.

LEGEND
B = Width of Washbasin base units
A = Top of the washbasin
D = Washbasin installation height
E = Thickness of washbasin plate
C = Top of washbasin plate
Y = Top of the base unit
X = Position wastewater connection