

Delivery time: 4-6 weeks / special washbasins 8 weeks

# Wings

Program 533



## Front colours

**F** foiled front



No. 764 Stonegrey matt



No. 777 cosmos grey matt

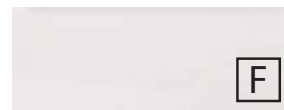

No. 793 noble white matt



No. 891 quarz grey matt



No. 893 titanium grey matt



No. 686 anthracite hgl.

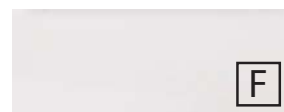

No. 722 polar white hgl.



no. 680 Charleston oak



no. 776 Charleston oak dark



Nr. 785 natural oak



no. 794 sand oak

## carcass colours

\* High gloss carcass for an additional price



No. 164  
Stonegrey matt



No. 177  
cosmos grey  
matt

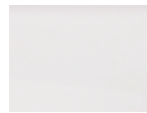

No. 111  
white matt



no. 191  
quarz grey  
matt



No. 193  
titanium grey  
matt



\*no. 121  
anthracite  
hgl.



\*no. 161  
white hgl.



no. 180  
Charleston oak



no. 176  
Charleston oak  
dark



Nr. 185  
natural oak



no. 194  
sand oak

## Washbasin colours

### STONEPLUS washbasins



No. 61  
white

STONEPLUS®

### Glass washbasin



no. 82  
optiwhite



no. 92  
optiwhite matt

## Handle versions

### Standard handle



no. 590 bar handle chrom

### Optional handles also suitable for additional cabinets



No. 537  
Strip handle chrome



no. 548  
Strip handle aluminium  
matt



No. 549  
Strip handle black matt







## pull-out element

Pull out with premium soft close  
door with integrated buffered closing

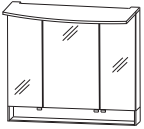
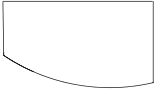
Illustrations and specifications are without obligation. Technical modifications reserved.  
2023/2024

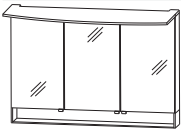
# CONCEPT LINE Wings - model list

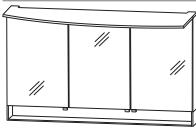
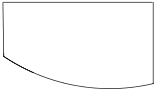





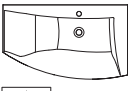

Additional units and accessories - see separate chapter

Depth indication corresponds to the carcass depth		Depth in mm	Width in mm	Height in mm	Article number	Hinge	Surcharge high-gloss carcass
<p><b>Mirror cabinets</b></p>							
   Ill. = left	<p><b>mirror cabinet</b>                      3 double mirror doors                      1 LED panel light, profil milled                      13,2 watt / converter 30watt                      1 illuminated shelf (4,08 watt)                      1080 + 506 lumens / 2700 - 6500 Kelvin                      2 central partitions,                      6 glass shelves                      1 switch socket element                      1 sensor switcher to control cold white and warm white with 3 dimming levels                      Door width:                      238 mm / 412 mm / 238 mm door height: 636 mm                      This product contains a light source with energy efficiency class: F</p> <p>Additional accessories                      LED washbasin lighting emotion                      additional socket on request</p>	150	900	810	<b>S 2 A 5 5 9 0 S 1</b>	L/R	
					P Z 1 1 5 0 9 0		
   Ill. = left	<p><b>mirror cabinet</b>                      3 double mirror doors                      1 LED panel light, profil milled                      17,8 watt / converter 30 watt                      1 illuminated shelf (5,5 watt)                      1462 + 685 lumens / 2700 - 6500 Kelvin                      2 central partitions,                      6 glass shelves                      1 switch socket element                      1 sensor switcher to control cold white and warm white with 3 dimming levels                      Door width:                      388 mm / 412 mm / 388 mm door height: 636 mm                      This product contains a light source with energy efficiency class: F</p> <p>Additional accessories                      LED washbasin lighting emotion                      additional socket on request</p>	150	1200	810	<b>S 2 A 5 5 1 2 S 1</b>	L/R	
					P Z 1 1 5 0 1 2		
   Ill. = left	<p><b>mirror cabinet</b>                      3 double mirror doors                      1 LED panel light, profil milled                      20,9 watt / converter 60 watt                      1 illuminated shelf (6,5 watt)                      1717 + 804 lumens / 2700 - 6500 Kelvin                      2 central partitions,                      6 glass shelves                      1 switch socket element                      1 sensor switcher to control cold white and warm white with 3 dimming levels                      Door width:                      446 mm / 496 mm / 446 mm door height: 636 mm                      This product contains a light source with energy efficiency class: F</p> <p>Additional accessories                      LED washbasin lighting emotion                      additional socket on request</p>	150	1400	810	<b>S 2 A 5 5 1 4 S 1</b>	L/R	
					P Z 1 1 5 0 1 2		

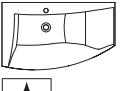
Please observe the product details of the accessories in the separate index.

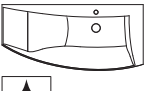
# CONCEPT LINE Wings - model list

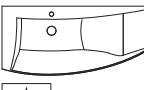





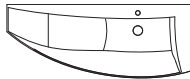

Additional units and accessories - see separate chapter

Depth indication corresponds to the carcass depth		Depth in mm	Width in mm	Height in mm	Article number	Hinge	Surcharge high-gloss carcass
<b>Washbasins</b>							
  	<b>washbasin 900 mm</b> incl. CLOU drain and overflow system in chrome can be combined with WUA 3690 09 L						
	<b>STONEPLUS - washbasin white</b>	540	906	30	<b>WMS 1 0 9 L 6 1</b>		
	<b>Glass washbasin optiwhite</b>	540	906	12	<b>SWG 1 0 9 L 8 2</b>		
	<b>Glass washbasin optiwhite matt</b>	540	906	12	<b>SWG 1 0 9 L 9 2</b>		
	Additional accessories Neutrally bonding silicone for glass washbasins Additional price for washbasin without tap hole*				P Z 1 2 3 5		
  	<b>washbasin 900 mm</b> incl. CLOU drain and overflow system in chrome can be combined with WUA 3690 09 R						
	<b>STONEPLUS - washbasin white</b>	540	906	30	<b>WMS 1 0 9 R 6 1</b>		
	<b>Glass washbasin optiwhite</b>	540	906	12	<b>SWG 1 0 9 R 8 2</b>		
	<b>Glass washbasin optiwhite matt</b>	540	906	12	<b>SWG 1 0 9 R 9 2</b>		
	Additional accessories Neutrally bonding silicone for glass washbasins Additional price for washbasin without tap hole*				P Z 1 2 3 5		
  	<b>washbasin 1200 mm</b> incl. CLOU drain and overflow system in chrome can be combined with WUA 3612 09 L						
	<b>STONEPLUS - washbasin white</b>	560	1206	30	<b>WMS 1 1 2 L 6 1</b>		
	<b>Glass washbasin optiwhite</b>	560	1206	12	<b>SWG 1 1 2 L 8 2</b>		
	<b>Glass washbasin optiwhite matt</b>	560	1206	12	<b>SWG 1 1 2 L 9 2</b>		
	Additional accessories Neutrally bonding silicone for glass washbasins Additional price for washbasin without tap hole*				P Z 1 2 3 5		
  	<b>washbasin 1200 mm</b> incl. CLOU drain and overflow system in chrome can be combined with WUA 3612 09 R						
	<b>STONEPLUS - washbasin white</b>	560	1206	30	<b>WMS 1 1 2 R 6 1</b>		
	<b>Glass washbasin optiwhite</b>	560	1206	12	<b>SWG 1 1 2 R 8 2</b>		
	<b>Glass washbasin optiwhite matt</b>	560	1206	12	<b>SWG 1 1 2 R 9 2</b>		
	Additional accessories Neutrally bonding silicone for glass washbasins Additional price for washbasin without tap hole*				P Z 1 2 3 5		

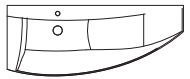
\*Delivery time: 8 weeks. Price per washbasin. Washbasin without tap hole is incompatible with CLOU System. Please check your order confirmation for correctness.

# CONCEPT LINE Wings - model list



Additional units and accessories - see separate chapter

Depth indication corresponds to the carcass depth		Depth in mm	Width in mm	Height in mm	Article number	Hinge	Surcharge high-gloss carcass
<b>Washbasins</b>							
	<b>washbasin 1400 mm</b> incl. CLOU drain and overflow system in chrome can be combined with WUA 3614 09 L						
	<b>STONEPLUS - washbasin white</b>	560	1406	30	<b>WMS 1 1 4 L 6 1</b>		
	<b>Glass washbasin optiwhite</b>	560	1406	12	<b>SWG 1 1 4 L 8 2</b>		
	<b>Glass washbasin optiwhite matt</b>	560	1406	12	<b>SWG 1 1 4 L 9 2</b>		
	Additional accessories Neutrally bonding silicone for glass washbasins Additional price for washbasin without tap hole*				P Z 1 2 3 5		
<b>Washbasin 1400 mm</b> incl. CLOU drain and overflow system in chrome can be combined with WUA 3614 09 R							
	<b>STONEPLUS - washbasin white</b>	560	1406	30	<b>WMS 1 1 4 R 6 1</b>		
	<b>Glass washbasin optiwhite</b>	560	1406	12	<b>SWG 1 1 4 R 8 2</b>		
	<b>Glass washbasin optiwhite matt</b>	560	1406	12	<b>SWG 1 1 4 R 9 2</b>		
	Additional accessories Neutrally bonding silicone for glass washbasins Additional price for washbasin without tap hole*				P Z 1 2 3 5		
<b>Washbasin base units</b>							
	<b>Washbasin base unit</b> 1 metal pull out unit with buffered closing 1 metal pull out unit with buffered closing and rail sidewise carcass depth- narrow = 300 mm sidewise carcass depth - wide = 470 mm	519	900	480	<b>WUA 3 6 9 0 0 9</b>	L/R	
	Additional accessories socket element Space-saving drain sten trap DN 40 Space-saving drain sten trap DN 32				P Z 1 0 9 5 P Z 1 3 6 7 P Z 1 4 2 3		
Ill. = left							
	<b>Washbasin base unit</b> 1 metal pull out unit with buffered closing 1 metal pull out unit with buffered closing and rail sidewise carcass depth- narrow = 300 mm sidewise carcass depth - wide = 470 mm	538	1200	480	<b>WUA 3 6 1 2 0 9</b>	L/R	
	Additional accessories socket element Space-saving drain sten trap DN 40 Space-saving drain sten trap DN 32				P Z 1 0 9 5 P Z 1 3 6 7 P Z 1 4 2 3		
Ill. = left							

\*Delivery time: 8 weeks. Price per washbasin. Washbasin without tap hole is incompatible with CLOU System. Please check your order confirmation for correctness.

# CONCEPT LINE Wings - model list

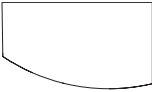
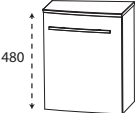

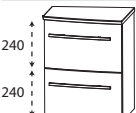
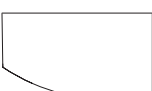
Additional units and accessories - see separate chapter

Depth indication corresponds to the carcass depth		Depth in mm	Width in mm	Height in mm	Article number	Hinge	Surcharge high-gloss carcass
<h3>Washbasin base units</h3>  <p><b>Washbasin base unit</b>            1 metal pull out unit with buffered closing            1 metal pull out unit with buffered closing and rail            1 internal compartment incl. glass shelf (width: 200 mm)            sidewise carcass depth- narrow = 160 mm            sidewise carcass depth - wide = 470 mm</p>  <p>III. = left</p> <p>Additional accessories            socket element            Space-saving drain stench trap DN 40            Space-saving drain stench trap DN 32</p>		538	1400	480	<b>WUA 3 6 1 4 0 9</b>	L/R	<b>1084</b>
					P Z 1 0 9 5 P Z 1 3 6 7 P Z 1 4 2 3		
<h3>Base units</h3>  <p><b>Base unit with shelf</b>            1 door            1 glass shelf            sidewise carcass depth- narrow = 300 mm            sidewise carcass depth = 425 mm</p>  <p>III. = left</p>							
					<b>UTA 3 1 4 A 6 1</b>	L/R	
<p><b>Push-fit shelf STONEPLUS</b></p> <p><b>top cover glass Optiwhite</b></p> <p><b>top cover glass Optiwhite matt</b></p> <p>fitting distance 150-200 mm            drawing left, according to washbasin unit</p>		425	400	510	<b>UTA 3 1 4 A 8 2</b>	L/R	
		425	400	492	<b>UTA 3 1 4 A 9 2</b>	L/R	
 <p><b>Base unit with shelf</b>            2 metal pull-out units with buffered closing incl. drawer rail            sidewise carcass depth- narrow = 300 mm            sidewise carcass depth = 425 mm</p>  <p>III. = left</p>							
					<b>UTA 3 6 4 A 6 1</b>	L/R	
<p><b>Push-fit shelf STONEPLUS</b></p> <p><b>top cover glass Optiwhite</b></p> <p><b>top cover glass Optiwhite matt</b></p> <p>fitting distance 150-200 mm            drawing left, according to washbasin unit</p>		425	400	510	<b>UTA 3 6 4 A 8 2</b>	L/R	
		425	400	492	<b>UTA 3 6 4 A 9 2</b>	L/R	

Please observe the product details of the accessories in the separate index.

# CONCEPT LINE Wings GUEST BATHROOM - model list

Additional units and accessories - see separate chapter

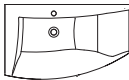
Depth indication corresponds to the carcass depth	Depth in mm	Width in mm	Height in mm	Article number	Hinge	Surcharge high-gloss carcass
<b>Mirror cabinets</b>						
 <p><b>mirror cabinet</b>            2 double mirror doors            1 LED panel light, profil milled            8,5 watt / converter 15 watt            1 illuminated shelf (2,64 watt)            700 + 327 lumens / 2700 - 6500 Kelvin            2 glass shelves            1 switch socket element            1 sensor switcher to control cold white and warm white with 3 dimming levels            Door width: 196 mm / 396 mm            This product contains a light source with energy efficiency class: F</p>  <p><b>wider door right</b>  <b>wider door left</b></p> <p>Additional accessories            LED washbasin lighting emotion</p>	150  150	600  600	810  810	<b>S 2 A 5 5 6 L S 1</b> <b>S 2 A 5 5 6 R S 1</b>  P Z 1 1 5 0 6 0		
<b>Set GUEST BATHROOM</b>						
  <p><b>Consisting of:</b>            STONEPLUS washbasin, 600 mm            colour white            incl. not lockable flow-off valve            Washbasin base unit            1 metal pull out unit with buffered closing            sidewise carcass depth- narrow = 300 mm            sidewise carcass depth - wide = 400 mm</p> <p>STONEPLUS            Ill. = right</p> <p>Additional accessories            Space-producing drain stench trap DN 32            Additional price for washbasin without tap hole*</p>	448	606	350	<b>S E T F G 6 S 0 7</b>  P Z 1 4 0 7	L/R	

\*Delivery time: 8 weeks. Price per washbasin. Washbasin without tap hole is incompatible with CLOU System. Please check your order confirmation for correctness.

# CONCEPT LINE Wings - bathroom variations

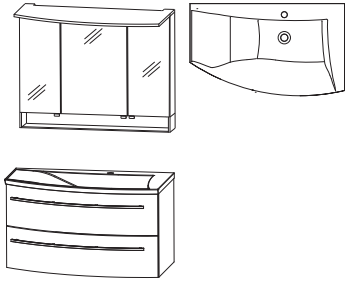
WIM-0190-L2			
1	Mirror cabinet LED 900 mm	S 2 A 5 5 9 0 S 1	
1	STONEPLUS washbasin, 900 mm	W M S 1 0 9 L 6 1	
1	washbasin base unit 900 mm	W U A 3 6 9 0 0 9	
		Sum	
W I G 8 2 9 0 L 2	SWG 109L 82 glass optiwhite inst. STONEPLUS	Sum	900 mm wide Ill. = left
W I G 9 2 9 0 L 2	SWG 109L 92 glass optiwhite matt inst. STONEPLUS	Sum	
		Surcharge high-gloss carcass	

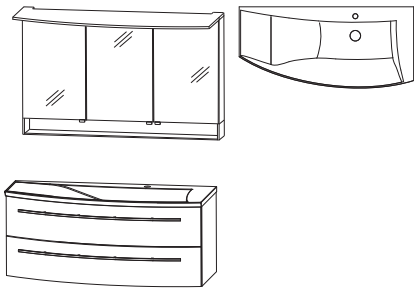
WIM-0112-L2			
1	Mirror cabinet LED 1200 mm	S 2 A 5 5 1 2 S 1	
1	STONEPLUS washbasin, 1.200 mm	W M S 1 1 2 L 6 1	
1	washbasin base unit 1200 mm	W U A 3 6 1 2 0 9	
		Sum	
W I G 8 2 1 2 L 2	SWG 112L 82 glass optiwhite inst. STONEPLUS	Sum	1200 mm wide Ill. = left
W I G 9 2 1 2 L 2	SWG 112L 92 glass optiwhite matt inst. STONEPLUS	Sum	
		Surcharge high-gloss carcass	

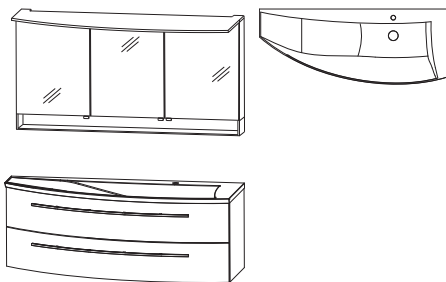
WIM-0114-L2			
1	Mirror cabinet LED 1400 mm	S 2 A 5 5 1 4 S 1	
1	STONEPLUS washbasin, 1400 mm	W M S 1 1 4 L 6 1	
1	washbasin base unit 1400 mm	W U A 3 6 1 4 0 9	
		Sum	
W I G 8 2 1 4 L 2	SWG 114L 82 glass optiwhite inst. STONEPLUS	Sum	1400 mm wide Ill. = left
W I G 9 2 1 4 L 2	SWG 114L 92 glass optiwhite matt inst. STONEPLUS	Sum	
		Surcharge high-gloss carcass	

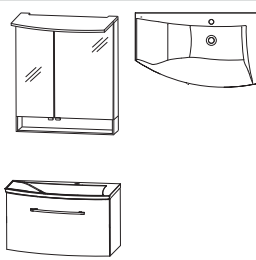
WIM-0160-L2			
1	Mirror cabinet LED, 600 mm	S 2 A 5 5 6 L S 1	
1	washbasin & base unit	S E T F G 6 S 0 7	
		Sum	
		Surcharge high-gloss carcass	
			reduced depth
			600 mm wide Ill. = left

Please observe a matching space-saving drain stench trap in the separate index accessories.



# CONCEPT LINE Wings - dimensional drawings

WMS 106L

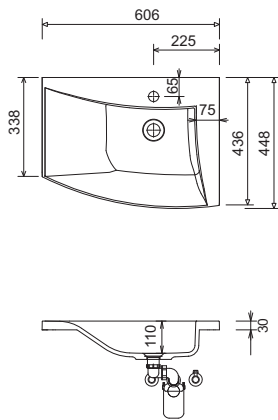

WMS 109L

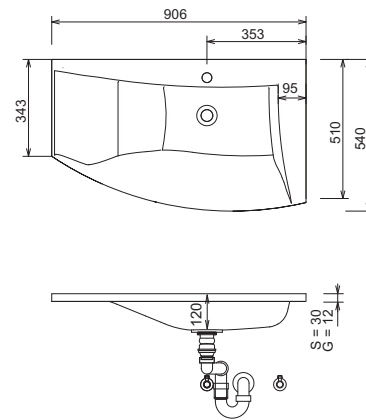

WMS 109R

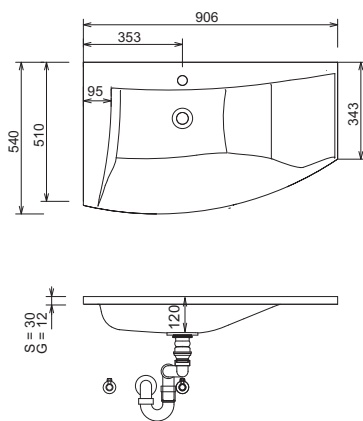

WMS 112L

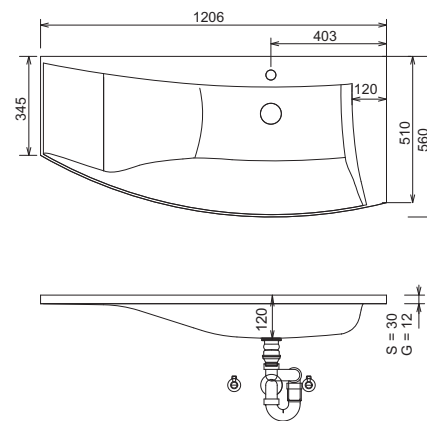

WMS 112R

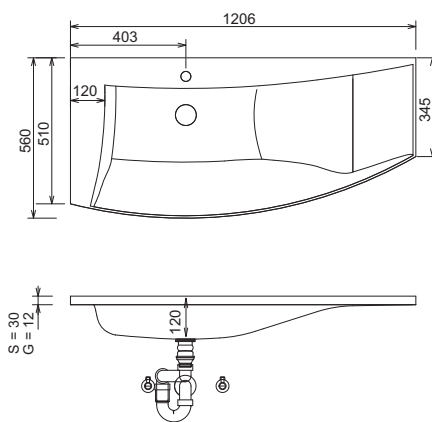

WMS 114L

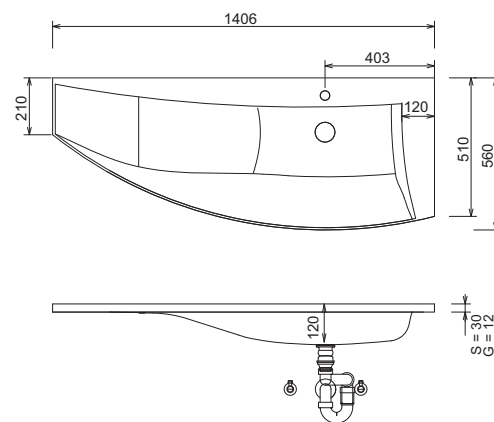

## LEGEND

S = STONEPLUS washbasin  
G = Glass washbasin

**Washing stands without anchoring brackets have to be fixed on the wall and on the furniture-side with silicon!**

**STONEPLUS:**

The water temperature must not exceed 55° C / 131° F. Hair tinting lotions have to be removed in a few seconds, so that staining can be avoided.

**Modifications:**

Technical modifications (+/- 5mm) and flatness modifications (DIN 18202) are subject of the usual material-specific modifications for construction materials, based on DIN 18202.

# CONCEPT LINE Wings - dimensional drawings

WMS 114R

GUEST BATHROOM

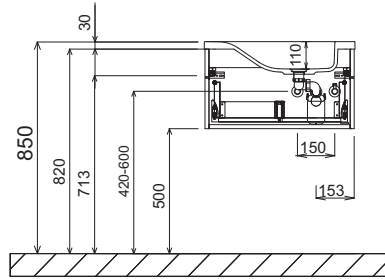
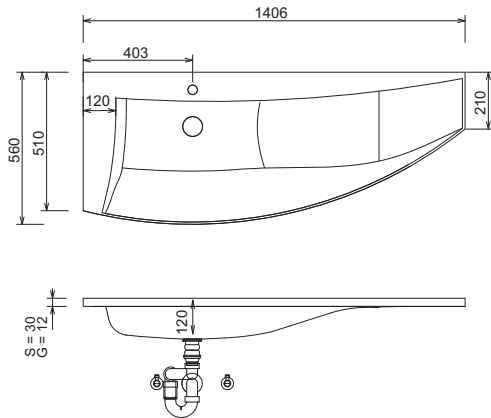

Single washbasin left 900 mm wide

Single washbasin right 900 mm wide

Washbasin height corresponds to the height of the Stoneplus washbasin

Washbasin height corresponds to the height of the Stoneplus washbasin

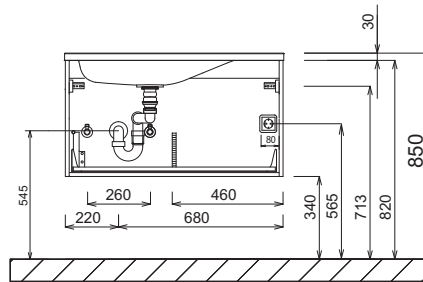
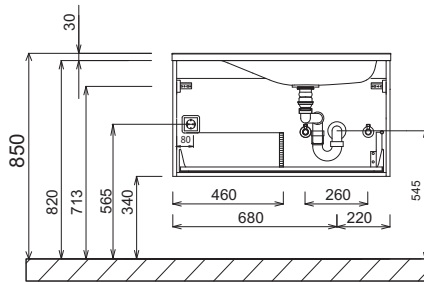

Single washbasin left 1200 mm wide

Single washbasin right 1200 mm wide

Washbasin height corresponds to the height of the Stoneplus washbasin

Washbasin height corresponds to the height of the Stoneplus washbasin

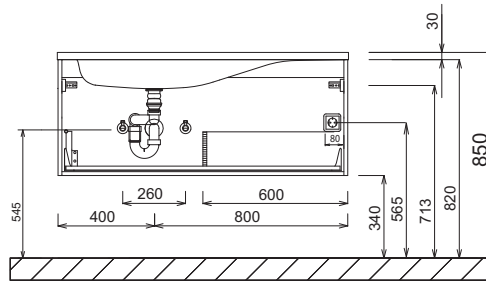
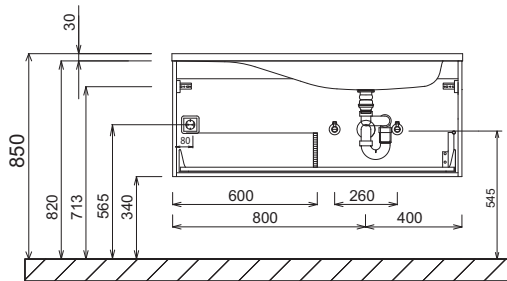

**Washing stands without anchoring brackets have to be fixed on the wall and on the furniture-side with silicon!**

**STONEPLUS:**

The water temperature must not exceed 55° C / 131° F. Hair tinting lotions have to be removed in a few seconds, so that staining can be avoided.

**Modifications:**

Technical modifications (+/- 5mm) and flatness modifications (DIN 18202) are subject of the usual material-specific modifications for construction materials, based on DIN 18202.

**LEGEND**

S = STONEPLUS washbasin  
G = Glass washbasin

# CONCEPT LINE Wings - dimensional drawings

Single washbasin left 1400 mm wide  
Washbasin height corresponds to the height of the Stoneplus washbasin

Single washbasin right 1400 mm wide  
Washbasin height corresponds to the height of the Stoneplus washbasin

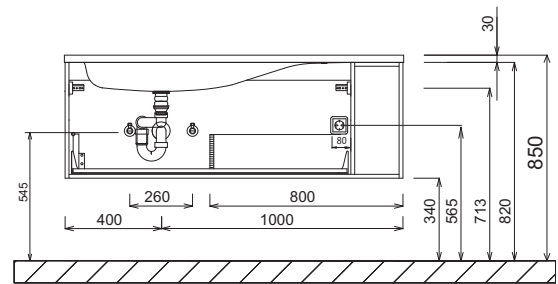
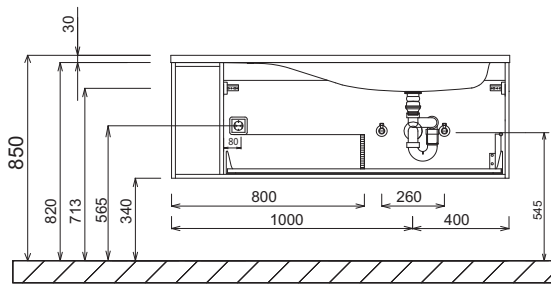

## electrical connections for mirror cabinets

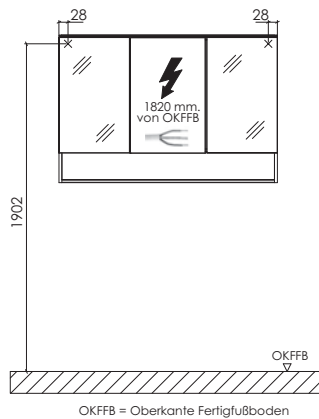

**LEGEND**  
S = STONEPLUS washbasin  
G = Glass washbasin

**Washing stands without anchoring brackets have to be fixed on the wall and on the furniture-side with silicon!**

**STONEPLUS:**

The water temperature must not exceed 55° C / 131° F. Hair tinting lotions have to be removed in a few seconds, so that staining can be avoided.

**Modifications:**

Technical modifications (+/- 5mm) and flatness modifications (DIN 18202) are subject of the usual material-specific modifications for construction materials, based on DIN 18202.