

Delivery time: 4-6 weeks

# brio

Program 558



## Front colours

**F** foiled front

handleless:



No. 677 cosmos grey matt



No. 672 polar white hgl.



no. 676 Charleston oak



Nr. 695 natural oak



no. 675 sand oak

with handle:



No. 777 cosmos grey matt



No. 722 polar white hgl.



no. 680 Charleston oak



Nr. 785 natural oak



no. 794 sand oak

## carcass colours

\* High gloss carcass for an additional price



No. 177  
cosmos grey matt

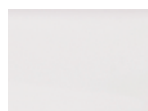

No. 111  
white matt

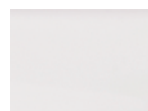

\*no. 161  
white hgl.



no. 180  
Charleston oak



Nr. 185  
natural oak



no. 194  
sand oak

## Washbasin colours

Cast mineral washbasins

No. 1 white



## Handle versions

Standard handle

handleless with recessed grip



No. 520 bar handle chrome



Optional handle strips

No. 537

Strip handle chrome



no. 548

Strip handle aluminium matt



No. 549

Strip handle black matt



## pull-out element

door with integrated buffered closing

No. 559

Pull outs and drawers with soft close





Illustrations and specifications are without obligation. Technical modifications reserved.  
2023/2024

Br.2

Please note the instruction for warranty, mounting and care, and the quality agreements as well, at the beginning of the book.

# EASY LINE brio - model list

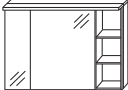

For further supplementary cupboards and accessories, see separate tabs

| Depth indication corresponds to the carcass depth  | Depth in mm   | Width in mm | Height in mm | Article number | Hinge                    | Surcharge high-gloss carcass |
|--|---|-------------|--------------|----------------|--------------------------|------------------------------|
| <b>Mirrors</b>   |   |             |              |                |                          |                              |
|                               | <p><b>Mirror</b><br/>LED- lighting above horizontal<br/>8,4 watt / Converter 15 watt<br/>647 lumens / 6000 Kelvin<br/>incl. toggle switch<br/>This product contains a light source with energy efficiency class: G</p>  | 43          | 900          | 656            | <b>F S A 4 3 9 0 1 1</b> |                              |
|                               | <p><b>Mirror</b><br/>LED- lighting above horizontal<br/>11,3 watt / Converter 15 watt<br/>1385 lumens / 6000 Kelvin<br/>incl. toggle switch<br/>This product contains a light source with energy efficiency class: E</p>  | 43          | 1200         | 656            | <b>F S A 4 3 1 2 1 1</b> |                              |
| <b>Mirror cabinets</b>   |   |             |              |                |                          |                              |
|  <p>incl. handle blocks</p> | <p><b>mirror cabinet</b><br/>2 mirror doors on wooden-plated incl. inside mirror<br/>1 glass shelf<br/>1 switch socket element<br/>1 LED panel light (17,0 watt)<br/>1700 lumens / 6000 Kelvin<br/>1 LED converter 30 W<br/>1 shelf 200 mm with 2 fixed wooden shelves<br/>Door width: 496 mm / 196 mm<br/>This product contains a light source with energy efficiency class: F</p> <p>Additional accessories<br/>LED washbasin lighting<br/>further sockets possible - see accessories</p> | 150         | 900          | 648            | <b>S E T 4 2 9 0 3 L</b> | P Z 1 0 6 3 6 0              |
|  <p>incl. handle blocks</p> | <p><b>mirror cabinet</b><br/>2 mirror doors on wooden-plated incl. inside mirror<br/>1 glass shelf<br/>1 switch socket element<br/>1 LED panel light (17,0 watt)<br/>1700 lumens / 6000 Kelvin<br/>1 LED converter 30 W<br/>1 shelf 200 mm with 2 fixed wooden shelves<br/>Door width: 196 mm / 496 mm<br/>This product contains a light source with energy efficiency class: F</p> <p>Additional accessories<br/>LED washbasin lighting<br/>further sockets possible - see accessories</p> | 150         | 900          | 648            | <b>S E T 4 2 9 0 3 R</b> | P Z 1 0 6 3 6 0              |

Please observe the product details of the accessories in the separate index.

# EASY LINE brío - model list

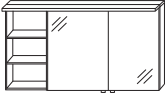
For further supplementary cupboards and accessories, see separate tabs

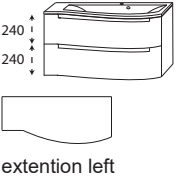
| Depth indication corresponds to the carcass depth  | Depth in mm | Width in mm | Height in mm | Article number  | Hinge | Surcharge high-gloss carcass |
|--|-------------|-------------|--------------|---|-------|------------------------------|
|  <p>incl. handle blocks</p> <p><b>mirror cabinet</b><br/>           2 mirror doors on wooden-plated incl. inside mirror<br/>           1 glass shelf<br/>           1 switch socket element<br/>           1 LED panel light (22,2 watt)<br/>           2220 lumens / 6000 Kelvin<br/>           1 LED converter 30 W<br/>           1 shelf 300 mm wide<br/>           2 fixed wooden shelves<br/>           Door width: 496 mm / 396 mm<br/>           This product contains a light source with energy efficiency class: F</p> <p>Additional accessories<br/>           LED washbasin lighting<br/>           further sockets possible - see accessories</p>  | 150         | 1200        | 648          | <b>SET 4 2 1 2 3 L</b><br><br><br><br><br><br><br><br><br>P Z 1 0 6 3 9 0   |       |                              |
|  <p>incl. handle blocks</p> <p><b>mirror cabinet</b><br/>           2 mirror doors on wooden-plated incl. inside mirror<br/>           1 glass shelf<br/>           1 switch socket element<br/>           1 LED panel light (22,2 watt)<br/>           2220 lumens / 6000 Kelvin<br/>           1 LED converter 30 W<br/>           1 shelf 300 mm wide<br/>           2 fixed wooden shelves<br/>           Door width: 396 mm / 496 mm<br/>           This product contains a light source with energy efficiency class: F</p> <p>Additional accessories<br/>           LED washbasin lighting<br/>           further sockets possible - see accessories</p>   | 150         | 1200        | 648          | <b>SET 4 2 1 2 3 R</b><br><br><br><br><br><br><br><br><br>P Z 1 0 6 3 9 0   |       |                              |
| <p><b>Sets handleless</b></p>  <p>extention left</p> <p><b>Consisting of:</b><br/>           washbasin, cast mineral, white, 912 mm<br/>           washbasin base unit 900 mm<br/>           1 metal pull out unit with buffered closing<br/>           1 metal pull-out with buffered closing incl. drawer rail<br/>           left carcass depth = 415 mm<br/>           right carcass depth = 445 mm</p> <p><b>without LED lighting</b><br/> <b>with LED lighting</b><br/>           1 LED converter 12 V, 15 Watt<br/>           302 lumens / 6500 Kelvin<br/>           incl. toggle switch<br/>           This product contains a light source with energy efficiency class: F</p> <p>Additional accessories<br/>           motion sensor for LED lighting<br/>           Space-saving drain stretch trap DN 40<br/>           Space-saving drain stretch trap DN 32</p> | 510<br>510  | 912<br>912  | 508<br>508   | <b>SET P 2 0 9 L</b><br><b>SET P 2 0 9 B L</b><br><br><br><br><br><br><br><br><br>P Z 1 1 4 1<br>P Z 1 3 6 7<br>P Z 1 4 2 3 |       |                              |

Please observe the product details of the accessories in the separate index.

## EASY LINE brio - model list

For further supplementary cupboards and accessories, see separate tabs

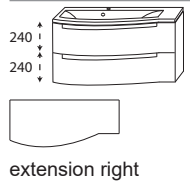
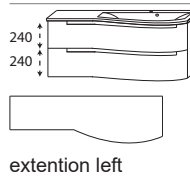
|   | Depth<br>in mm        | Width<br>in mm          | Height<br>in mm       | Article number   | Hinge | Surcharge high-gloss carcass |
|---|-----------------------|-------------------------|-----------------------|--|-------|------------------------------|
| <p>Depth indication corresponds to the carcass depth</p> <p><b>Sets handleless</b></p>  <p>extension right</p> <p><b>Consisting of:</b><br/> washbasin, cast mineral, white, 912 mm<br/> washbasin base unit 900 mm<br/> 1 metal pull out unit with buffered closing<br/> 1 metal pull-out with buffered closing incl. drawer rail<br/> left carcass depth = 445 mm<br/> right carcass depth = 415 mm</p> <p><b>without LED lighting</b><br/> <b>with LED lighting</b><br/> 1 LED converter 12 V, 15 Watt<br/> 302 lumens / 6500 Kelvin<br/> incl. toggle switch<br/> This product contains a light source with energy efficiency class: F</p> <p>Additional accessories<br/> motion sensor for LED lighting<br/> Space-saving drain stench trap DN 40<br/> Space-saving drain stench trap DN 32</p> | <p>510</p> <p>510</p> | <p>912</p> <p>912</p>   | <p>508</p> <p>508</p> | <p><b>S E T P 2 0 9 R</b><br/> <b>S E T P 2 0 9 B R</b></p> <p>P Z 1 1 4 1<br/> P Z 1 3 6 7<br/> P Z 1 4 2 3</p> |       |                              |
|  <p>extension left</p> <p><b>Consisting of:</b><br/> Washbasin, cast mineral, white, 1212 mm<br/> washbasin base unit 1200 mm<br/> 1 metal pull out unit with buffered closing<br/> 1 metal pull-out with buffered closing incl. drawer rail<br/> left carcass depth = 400 mm<br/> right carcass depth = 430 mm</p> <p><b>without LED lighting</b><br/> <b>with LED lighting</b><br/> 1 LED converter 12 V, 15 Watt<br/> 387 lumens / 6500 Kelvin<br/> incl. toggle switch<br/> This product contains a light source with energy efficiency class: F</p> <p>Additional accessories<br/> motion sensor for LED lighting<br/> Space-saving drain stench trap DN 40<br/> Space-saving drain stench trap DN 32</p>   | <p>517</p> <p>517</p> | <p>1212</p> <p>1212</p> | <p>508</p> <p>508</p> | <p><b>S E T P 2 1 2 L</b><br/> <b>S E T P 2 1 2 B L</b></p> <p>P Z 1 1 4 1<br/> P Z 1 3 6 7<br/> P Z 1 4 2 3</p> |       |                              |

Please observe the product details of the accessories in the separate index.

# EASY LINE brío - model list

For further supplementary cupboards and accessories, see separate tabs

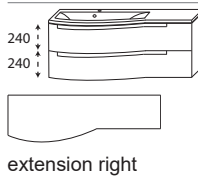
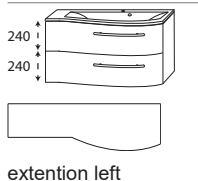
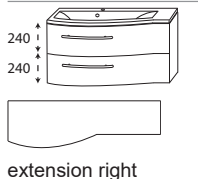
| Depth indication corresponds to the carcass depth   | Depth in mm | Width in mm  | Height in mm | Article number   | Hinge | Surcharge high-gloss carcass |
|---|-------------|--------------|--------------|--|-------|------------------------------|
| <b>Sets handleless</b>  |             |              |              |  |       |                              |
|  <p>extension right</p> <p><b>Consisting of:</b><br/>           Washbasin, cast mineral, white, 1212 mm<br/>           washbasin base unit 1200 mm<br/>           1 metal pull out unit with buffered closing<br/>           1 metal pull-out with buffered closing incl. drawer rail<br/>           left carcass depth = 430 mm<br/>           right carcass depth = 400 mm</p> <p><b>without LED lighting</b><br/> <b>with LED lighting</b><br/>           1 LED converter 12 V, 15 Watt<br/>           387 lumens / 6500 Kelvin<br/>           incl. toggle switch<br/>           This product contains a light source with energy efficiency class: F</p> <p>Additional accessories<br/>           motion sensor for LED lighting<br/>           Space-saving drain stench trap DN 40<br/>           Space-saving drain stench trap DN 32</p> | 517<br>517  | 1212<br>1212 | 508<br>508   | <b>SET P 2 1 2 R</b><br><b>SET P 2 1 2 BR</b><br><br>P Z 1 1 4 1<br>P Z 1 3 6 7<br>P Z 1 4 2 3 |       |                              |
| <b>Sets with handles</b>  |             |              |              |  |       |                              |
|  <p>extension left</p> <p><b>Consisting of:</b><br/>           washbasin, cast mineral, white, 912 mm<br/>           washbasin base unit 900 mm<br/>           1 metal pull out unit with buffered closing<br/>           1 metal pull-out with buffered closing incl. drawer rail<br/>           left carcass depth = 415 mm<br/>           right carcass depth = 445 mm</p> <p>Additional accessories<br/>           Space-saving drain stench trap DN 40<br/>           Space-saving drain stench trap DN 32</p>   | 510         | 912          | 508          | <b>SET P 2 2 9 L</b><br><br>P Z 1 3 6 7<br>P Z 1 4 2 3   |       |                              |
|  <p>extension right</p> <p><b>Consisting of:</b><br/>           washbasin, cast mineral, white, 912 mm<br/>           washbasin base unit 900 mm<br/>           1 metal pull out unit with buffered closing<br/>           1 metal pull-out with buffered closing incl. drawer rail<br/>           left carcass depth = 445 mm<br/>           right carcass depth = 415 mm</p> <p>Additional accessories<br/>           Space-saving drain stench trap DN 40<br/>           Space-saving drain stench trap DN 32</p>  | 510         | 912          | 508          | <b>SET P 2 2 9 R</b><br><br>P Z 1 3 6 7<br>P Z 1 4 2 3   |       |                              |

Please observe the product details of the accessories in the separate index.

## EASY LINE brio - model list

For further supplementary cupboards and accessories, see separate tabs

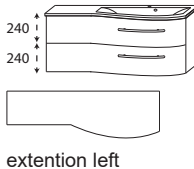
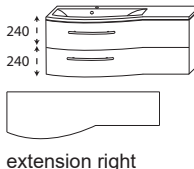
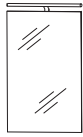
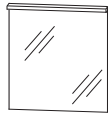
| Depth indication corresponds to the carcass depth  |  | Depth<br>in mm | Width<br>in mm | Height<br>in mm | Article number         | Hinge | Surcharge high-gloss carcass |
|--|--|----------------|----------------|-----------------|------------------------|-------|------------------------------|
| <h3>Sets with handles</h3>   |  |                |                |                 |                        |       |                              |
|  <p>extension left</p>  | <p><b>Consisting of:</b><br/>                     Washbasin, cast mineral, white, 1212 mm<br/>                     washbasin base unit 1200 mm<br/>                     1 metal pull out unit with buffered closing<br/>                     1 metal pull-out with buffered closing incl. drawer rail<br/>                     left carcass depth = 400 mm<br/>                     right carcass depth = 430 mm</p> <p>Additional accessories</p> <p>Space-saving drain stench trap DN 40<br/>                     Space-saving drain stench trap DN 32</p> | 517            | 1212           | 508             | <b>SET P 2 2 2 L</b>   |       |                              |
|  <p>extension right</p> | <p><b>Consisting of:</b><br/>                     Washbasin, cast mineral, white, 1212 mm<br/>                     washbasin base unit 1200 mm<br/>                     1 metal pull out unit with buffered closing<br/>                     1 metal pull-out with buffered closing incl. drawer rail<br/>                     left carcass depth = 430 mm<br/>                     right carcass depth = 400 mm</p> <p>Additional accessories</p> <p>Space-saving drain stench trap DN 40<br/>                     Space-saving drain stench trap DN 32</p> | 517            | 1212           | 508             | <b>SET P 2 2 2 R</b>   |       |                              |
| <h3>Mirrors GUEST BATHROOM</h3>  |  |                |                |                 |                        |       |                              |
|                       | <p><b>mirror, 400 mm</b><br/>                     outer edges in chrom<br/>                     1 LED surface-mounted lamp 400 mm<br/>                     6,5 Watt / converter 15 Watt<br/>                     760 lumens / 6000 Kelvin<br/>                     incl. toggle switch<br/>                     This product contains a light source with energy efficiency class: F</p>   | 28             | 400            | 800             | <b>FSA 5 1 4 0 B 3</b> |       |                              |
|                       | <p><b>Mirror</b><br/>                     LED- lighting above<br/>                     horizontal<br/>                     5,52 watt / Converter 15 watt<br/>                     425 lumens / 6000 Kelvin<br/>                     incl. toggle switch<br/>                     This product contains a light source with energy efficiency class: G</p>  | 43             | 600            | 656             | <b>FSA 4 3 6 0 1 1</b> |       |                              |

Please observe the product details of the accessories in the separate index.

# EASY LINE brío - model list

For further supplementary cupboards and accessories, see separate tabs

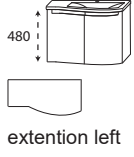
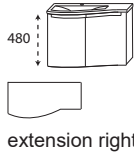
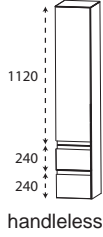
|  | Depth<br>in mm   | Width<br>in mm | Height<br>in mm | Article number     | Hinge | Surcharge high-gloss carcass |
|--|--|----------------|-----------------|--------------------|-------|------------------------------|
| Depth indication corresponds to the carcass depth                                  |  |                |                 |                    |       |                              |
| <b>Sets GUEST BATHROOM handleless</b>  |  |                |                 |                    |       |                              |
|    | <b>Consisting of:</b><br>washbasin, cast mineral, white, 612 mm<br>incl. permanent drain<br>Washbasin base unit 600 mm<br>2 doors<br>left carcass depth = 230 mm<br>right carcass depth = 270 mm   |                |                 |                    |       |                              |
|  | <b>without LED lighting</b><br><b>with LED lighting</b><br>1 LED converter 12 V, 15 Watt<br>302 lumens / 6500 Kelvin<br>incl. toggle switch<br><br>Additional accessories<br>motion sensor for LED lighting<br>Space-producing drain stench trap DN 32 |                |                 |                    |       |                              |
|  | 337  | 612            | 500             | <b>SETP206L</b>    |       |                              |
|  | 337  | 612            | 500             | <b>SETP206BL</b>   |       |                              |
|  |  |                |                 | PZ 1141<br>PZ 1407 |       |                              |
|   | <b>Consisting of:</b><br>washbasin, cast mineral, white, 612 mm<br>incl. permanent drain<br>Washbasin base unit 600 mm<br>2 doors<br>left carcass depth = 270 mm<br>right carcass depth = 230 mm   |                |                 |                    |       |                              |
|  | <b>without LED lighting</b><br><b>with LED lighting</b><br>1 LED converter 12 V, 15 Watt<br>302 lumens / 6500 Kelvin<br>incl. toggle switch<br><br>Additional accessories<br>motion sensor for LED lighting<br>Space-producing drain stench trap DN 32 |                |                 |                    |       |                              |
|  | 337  | 612            | 500             | <b>SETP206R</b>    |       |                              |
|  | 337  | 612            | 500             | <b>SETP206BR</b>   |       |                              |
|  |  |                |                 | PZ 1141<br>PZ 1407 |       |                              |
| <b>Tall units</b>  |  |                |                 |                    |       |                              |
|  | <b>Tall unit</b><br>1 door<br>4 glass shelves<br>2 pull-outs with buffered closing   |                |                 |                    |       |                              |
|  | Additional accessories<br>motion sensor for LED lighting<br>Space-producing drain stench trap DN 32  |                |                 |                    |       |                              |
|  | 300  | 300            | 1600            | <b>HNA08304</b>    | L/R   |                              |
|  | 300  | 400            | 1600            | <b>HNA08404</b>    | L/R   |                              |

Please observe the product details of the accessories in the separate index.



# EASY LINE brio - model list

For further supplementary cupboards and accessories, see separate tabs

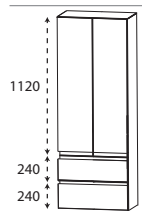
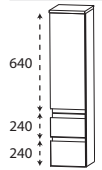
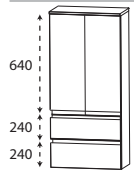
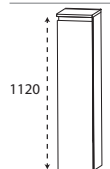
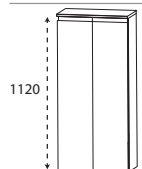
| Depth indication corresponds to the carcass depth  |  | Depth in mm | Width in mm | Height in mm | Article number   | Hinge | Surcharge high-gloss carcass |
|--|--|-------------|-------------|--------------|------------------|-------|------------------------------|
| <p><b>Tall units</b></p>  <p>handleless</p>     |  | 300         | 600         | 1600         | <b>HNA08604</b>  |       |                              |
| <p><b>Tall unit</b><br/>2 doors<br/>4 glass shelves<br/>2 pull-outs with buffered closing</p>                                    |  |             |             |              |                  |       |                              |
| <p><b>Central units</b></p>  <p>handleless</p> |  | 300         | 300         | 1136         | <b>MNA773A01</b> | L/R   |                              |
| <p><b>medium-high unit</b><br/>1 door<br/>1 glass shelf<br/>2 pull-outs with buffered closing<br/>1 top cover 325 mm deep</p>    |  | 300         | 400         | 1136         | <b>MNA774A01</b> | L/R   |                              |
|  <p>handleless</p>                            |  | 300         | 600         | 1136         | <b>MNA776A01</b> |       |                              |
| <p><b>medium-high unit</b><br/>2 doors<br/>1 glass shelf<br/>2 pull-outs with buffered closing<br/>1 top cover 325 mm deep</p>   |  |             |             |              |                  |       |                              |
|  <p>handleless</p>                            |  | 300         | 300         | 1136         | <b>MNA713A01</b> | L/R   |                              |
| <p><b>medium-high unit</b><br/>1 door<br/>3 glass shelves<br/>1 top cover 325 mm deep</p>  |  | 300         | 400         | 1136         | <b>MNA714A01</b> | L/R   |                              |
|  <p>handleless</p>                            |  | 300         | 600         | 1136         | <b>MNA716A01</b> |       |                              |
| <p><b>medium-high unit</b><br/>2 doors<br/>3 glass shelves<br/>1 top cover 325 mm deep</p>                                       |  |             |             |              |                  |       |                              |

Please observe the product details of the accessories in the separate index.

# EASY LINE brío - model list

For further supplementary cupboards and accessories, see separate tabs

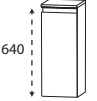
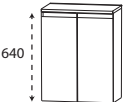
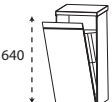
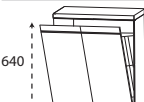
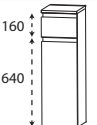
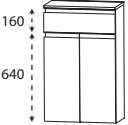
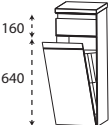
| Depth indication corresponds to the carcass depth  |  | Depth<br>in mm | Width<br>in mm | Height<br>in mm | Article number           | Hinge | Surcharge high-gloss carcass |
|--|--|----------------|----------------|-----------------|--------------------------|-------|------------------------------|
|  <p>640</p> <p>handleless</p>              | <p><b>Highboard</b><br/>1 door<br/>1 glass shelf<br/>1 top cover 325 mm deep</p>   | 300            | 300            | 656             | <b>H B A 4 1 3 A 0 1</b> | L/R   |                              |
|  |  | 300            | 400            | 656             | <b>H B A 4 1 4 A 0 1</b> | L/R   |                              |
|  <p>640</p> <p>handleless</p>              | <p><b>Highboard</b><br/>2 doors<br/>1 glass shelf<br/>1 top cover 325 mm deep</p>  | 300            | 600            | 656             | <b>H B A 4 1 6 A 0 1</b> |       |                              |
|  <p>640</p> <p>handleless</p>              | <p><b>Highboard with laundry basket</b><br/>1 laundry basket with wire basket<br/>1 top cover 325 mm deep</p>  | 300            | 300            | 656             | <b>H B A 4 1 3 W 0 1</b> |       |                              |
|  | <p>Volume of laundry basket: 25 liters</p> <p>Volume of laundry basket: 35 liters</p>  | 300            | 400            | 656             | <b>H B A 4 1 4 W 0 1</b> |       |                              |
|  <p>640</p> <p>handleless</p>            | <p><b>Highboard with laundry basket</b><br/>1 laundry basket with wire basket<br/>1 top cover 325 mm deep</p> <p>Volume of laundry basket: 55 liters</p> | 300            | 600            | 656             | <b>H B A 4 1 6 W 0 1</b> |       |                              |
|  <p>160</p> <p>640</p> <p>handleless</p> | <p><b>Highboard</b><br/>1 drawer with buffered closing<br/>1 door<br/>1 glass shelf<br/>1 top cover 325 mm deep</p>                                      | 300            | 300            | 816             | <b>H B A 5 5 3 A 0 1</b> | L/R   |                              |
|  |  | 300            | 400            | 816             | <b>H B A 5 5 4 A 0 1</b> | L/R   |                              |
|  <p>160</p> <p>640</p> <p>handleless</p> | <p><b>Highboard</b><br/>1 drawer with buffered closing<br/>2 doors<br/>1 glass shelf<br/>1 top cover 325 mm deep</p>                                     | 300            | 600            | 816             | <b>H B A 5 5 6 A 0 1</b> |       |                              |
|  |  |                |                |                 |                          |       |                              |
|  <p>160</p> <p>640</p> <p>handleless</p> | <p><b>Highboard with laundry basket</b><br/>1 drawer with buffered closing<br/>1 laundry basket with wire basket<br/>1 top cover 325 mm deep</p>         | 300            | 300            | 816             | <b>H B A 5 5 3 W 0 1</b> |       |                              |
|  | <p>Volume of laundry basket: 25 liters</p> <p>Volume of laundry basket: 35 liters</p>  | 300            | 400            | 816             | <b>H B A 5 5 4 W 0 1</b> |       |                              |

Please observe the product details of the accessories in the separate index.

# EASY LINE brio - model list

For further supplementary cupboards and accessories, see separate tabs

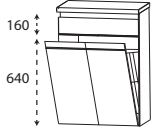
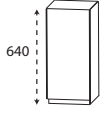
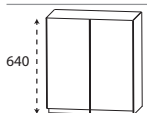
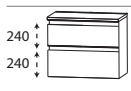
| Depth indication corresponds to the carcass depth   |  | Depth in mm       | Width in mm | Height in mm | Article number           | Hinge | Surcharge high-gloss carcass |
|---|--|-------------------|-------------|--------------|--------------------------|-------|------------------------------|
| <b>Highboards</b>   |  |                   |             |              |                          |       |                              |
|  <p>160<br/>640<br/>handleless</p>   | <p><b>Highboard with laundry basket</b><br/>           1 drawer with buffered closing<br/>           1 laundry basket with wire basket<br/>           1 top cover 325 mm deep<br/>           Volume of laundry basket: 55 liters</p> | 300               | 600         | 816          | <b>H B A 5 5 6 W 0 1</b> |       |                              |
|   |  | <b>Wall units</b> |             |              |                          |       |                              |
|  <p>640<br/>handleless</p>           | <p><b>Wall unit</b><br/>           1 door<br/>           1 glass shelf</p>   | 150               | 300         | 640          | <b>O G A 4 1 3 0</b>     | L/R   |                              |
|   |  | 150               | 400         | 640          | <b>O G A 4 1 4 0</b>     | L/R   |                              |
|  <p>640<br/>handleless</p>         | <p><b>Wall unit</b><br/>           2 doors<br/>           1 glass shelf</p>  | 150               | 600         | 640          | <b>O G A 4 1 6 0</b>     |       |                              |
| <b>Base units</b>   |  |                   |             |              |                          |       |                              |
|  <p>240<br/>240<br/>handleless</p> | <p><b>Base unit</b><br/>           2 pull-outs with buffered closing<br/>           1 top cover 325 mm deep</p>  | 300               | 300         | 496          | <b>U N A 3 6 3 A 0 1</b> |       |                              |
|   |  | 300               | 400         | 496          | <b>U N A 3 6 4 A 0 1</b> |       |                              |
|   |  | 300               | 600         | 496          | <b>U N A 3 6 6 A 0 1</b> |       |                              |

Please observe the product details of the accessories in the separate index.

# EASY • LINE brio - dimensional drawings

SET P209 (B)R / SET P229 R

SET P209 (B)L / SET P229 L

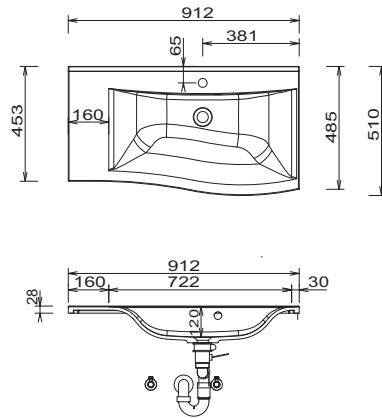
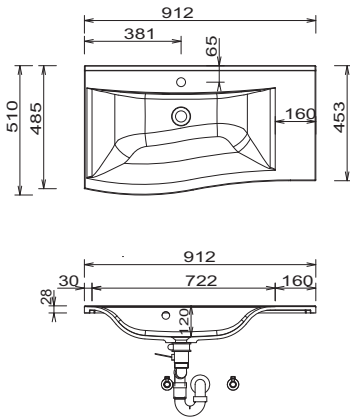

SET P212 (B)R / SET P222 R

SET P212 (B)L / SET P222 L

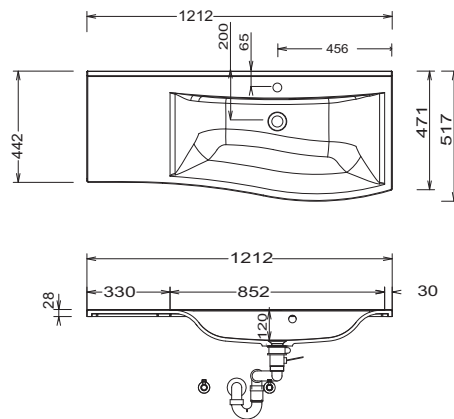
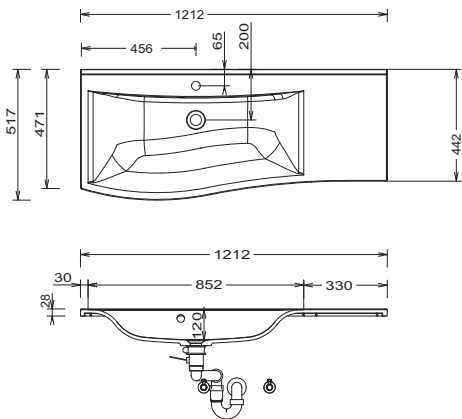

SET P206 (B)R

SET P206 (B)L

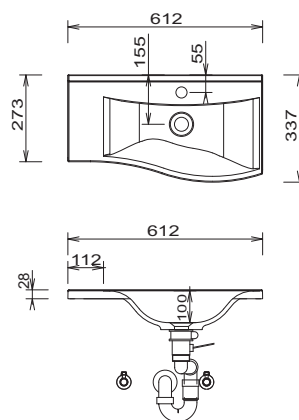
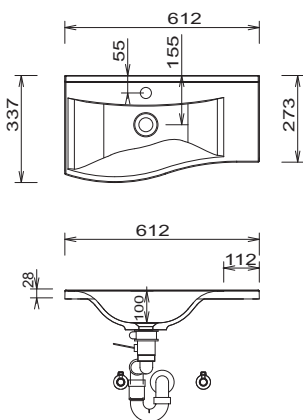

Cast mineral:  
 The water temperature must not exceed 55° C / 131° F. Hair tinting lotions have to be removed immediately, so that staining can be avoided.  
 Modifications:  
 Technical modifications (+/- 5mm) and flatness modifications (DIN 18202) are subject of the usual material-specific modifications for construction materials, based on DIN 18202.

**LEGEND**  
 B = Width of Washbasin base units  
 X = Position wastewater connection

# EASY • LINE brio - dimensional drawings

Single washbasin

GUEST BATHROOM

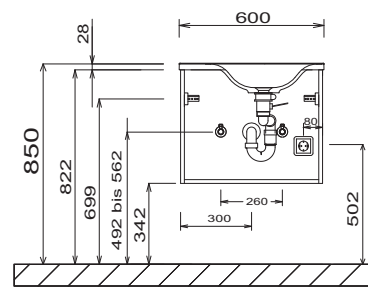
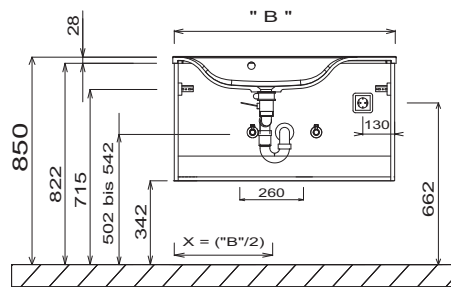

Mirror 400 mm

FSA 43xx 11

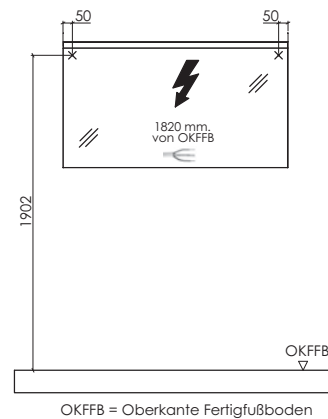
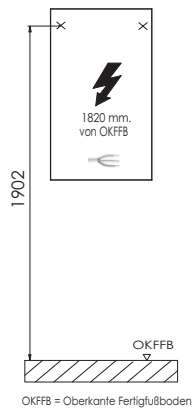

electrical connections for mirror cabinets

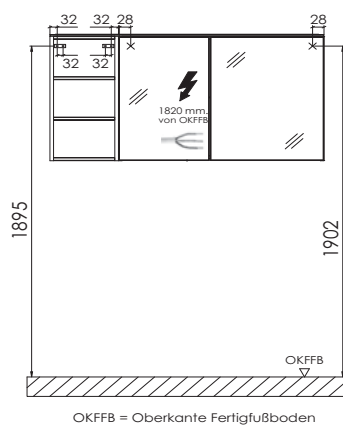

**LEGEND**  
 B = Width of Washbasin base units  
 X = Position wastewater connection

**Cast mineral:**  
 The water temperature must not exceed 55° C / 131° F. Hair tinting lotions have to be removed immediately, so that staining can be avoided.  
**Modifications:**  
 Technical modifications (+/- 5mm) and flatness modifications (DIN 18202) are subject of the usual material-specific modifications for construction materials, based on DIN 18202.