

Delivery time: 4-6 weeks

kera.home

program 553



Front colours

F foiled front

M Melamine coated front with ABS-edge



No. 679 concrete imitation



No. 764 Stonegrey matt



No. 777 cosmos grey matt



No. 793 noble white matt



No. 891 quarz grey matt



No. 893 titanium grey matt



No. 686 anthracite hgl.

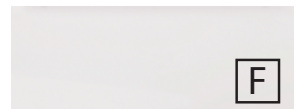

No. 722 polar white hgl.



No. 755 hacienda black



No. 769 hacienda grey

Expiry 12/2023



No. 639 Oak Black

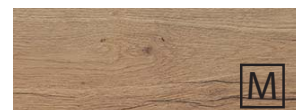

no. 670 Halifax oak



no. 680 Charleston oak



No. 750 cardiff oak



no. 751 Cuneo oak brown



no. 771 Cuneo oak natural



no. 776 Charleston oak dark



Nr. 785 natural oak



no. 794 sand oak

carcass colours

* High gloss carcass for an additional price



No. 179
concrete imitation



No. 164
Stonegrey matt



No. 177
cosmos grey matt

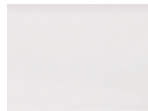

No. 111
white matt



no. 191
quarz grey matt



No. 193
titanium grey matt



*no. 121
anthracite hgl.



*no. 161
white hgl.



no. 155
hacienda black

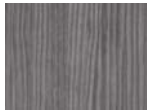

no. 169
hacienda grey
Expiry 12/2023



No. 139 Oak Black



no. 170
Halifax oak



no. 180
Charleston oak



no. 150
cardiff oak



no. 151
Cuneo oak brown



no. 171 Cuneo
oak natural



no. 176
Charleston oak dark



Nr. 185
natural oak



no. 194
sand oak

Handle version



No. 520 bar handle chrome

Washbasin colours

Ceramic washbasins



no. 1
white

Ceramic counter top washbasin



no. 1
white

pull-out element



No. 559

Pull outs and drawers with soft close

door with integrated buffered closing

Illustrations and specifications are without obligation. Technical modifications reserved.



2023/2024

Kh.2

Please note the instruction for warranty, mounting and care, and the quality agreements as well, at the beginning of the book.

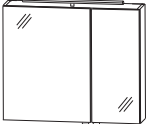

EASY LINE **kera.home** - model list

For further supplementary cupboards and accessories, see separate tabs

Depth indication corresponds to the carcass depth	Depth in mm	Width in mm	Height in mm	Article number	Hinge	Surcharge high-gloss carcass
Mirror cabinets						
 <p>incl. handle blocks Ill. = left</p>	<p>mirror cabinet 2 mirror doors on wooden-plated door with polished chrome edge ambient incl. inside mirror 1 glass shelf 1 LED converter 15 W 1 switch socket element This product contains a light source with energy efficiency class: F</p>					
<p>600 mm wide 1 LED surface-mounted lamp (6,5 Watt) 400 mm wide 760 lumens / 6500 Kelvin Door width: 396 mm / 196 mm</p>	150	600	640	S 2 A 4 3 6 A 9 0	L/R	
<p>800 mm wide 1 LED surface-mounted lamp (9,7 Watt) 600 mm wide 1140 lumens / 6500 Kelvin Door width: 496 mm / 296 mm</p>	150	800	640	S 2 A 4 3 8 A 9 0	L/R	
<p>Additional accessories LED washbasin lighting further sockets possible - see accessories</p>				P Z 1 0 6 3 6 0		
 <p>incl. handle blocks Ill. = left</p>	<p>mirror cabinet 2 mirror doors on wooden-plated door with polished chrome edge ambient incl. inside mirror 1 glass shelf 1 LED converter 15 W 1 switch socket element 1 LED surface-mounted lamp (9,7 Watt) 600 mm wide 1140 lumens / 6500 Kelvin Door width: 496 mm / 396 mm This product contains a light source with energy efficiency class: F</p>	150	900	640	S 2 A 4 3 9 A 9 0	L/R
<p>Additional accessories LED washbasin lighting further sockets possible - see accessories</p>				P Z 1 0 6 3 9 0		
 <p>incl. handle blocks</p>	<p>mirror cabinet 3 mirror doors on wooden-plated door with polished chrome edge ambient 2 central partitions, 3 glass shelves 1 LED surface-mounted lamp (13,6 Watt) 900 mm wide 1580 lumens / 6500 Kelvin 1 LED converter 30 W 1 switch socket element Door width: 388 mm / 412 mm / 388 mm This product contains a light source with energy efficiency class: F</p>	150	1200	640	S 2 A 4 3 1 2 9 0	
<p>Additional accessories LED washbasin lighting further sockets possible - see accessories</p>				P Z 1 0 6 3 1 2		

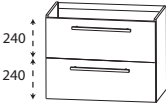
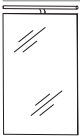

EASY LINE kera.home - model list

For further supplementary cupboards and accessories, see separate tabs

Depth indication corresponds to the carcass depth		Depth in mm	Width in mm	Height in mm	Article number	Hinge	Surcharge high-gloss carcass
Washbasin							
	Ceramic washbasin white with overflow 650 mm wide 850 mm wide 950 mm wide 1250 mm wide	450	650	60	WTK 7 0 6 5 1		
		450	850	60	WTK 7 0 8 5 1		
		450	950	60	WTK 7 0 9 5 1		
		450	1250	60	WTK 7 1 2 5 1		
Washbasin base units							
	Washbasin base unit 1 pull-out with cushioned closure and syphon cutout 1 pull-out with buffered closing incl. drawer rail 600 mm wide 800 mm wide 900 mm wide 1200 mm wide Additional accessories Space-saving drain stretch trap DN 40 Space-saving drain stretch trap DN 32	390	600	485	WUA 3 7 6 0 2 7		
		390	800	485	WUA 3 7 8 0 2 7		
		390	900	485	WUA 3 7 9 0 2 7		
		390	1200	485	WUA 3 7 1 2 2 7		
					P Z 1 3 6 7 P Z 1 4 2 3		
GUEST BATHROOM							
	mirror, 400 mm outer edges in chrom 1 LED surface-mounted lamp 400 mm 6,5 Watt / converter 15 Watt 760 lumens / 6000 Kelvin incl. toggle switch This product contains a light source with energy efficiency class: F	28	400	800	FSA 5 1 4 0 B 3		
	Consisting of: Ceramic counter top washbasin 500 mm incl. permanent drain 1 middle panel Washbasin base unit 400 mm 1 door Additional accessories Space-producing drain stretch trap DN 32	365	500	566	SETKH 5 0 1	L/R	
					P Z 1 4 0 7		

EASY LINE kera.home - model list

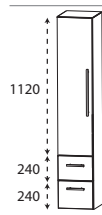
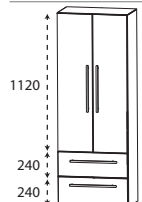
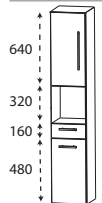
For further supplementary cupboards and accessories, see separate tabs

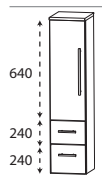
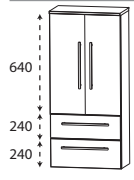
Depth indication corresponds to the carcass depth		Depth in mm	Width in mm	Height in mm	Article number	Hinge	Surcharge high-gloss carcass
Tall units							
	Tall unit 1 door 4 glass shelves 2 pull-outs with buffered closing	300	300	1600	HNA08304	L/R	
		300	400	1600	HNA08404	L/R	
	Tall unit 2 doors 4 glass shelves 2 pull-outs with buffered closing	300	600	1600	HNA08604		
	Tall unit 1 door 1 glass shelf (top) 1 open compartment 1 drawer with buffered closing 1 door 1 glass shelf	300	300	1600	HNA023001	L/R	
		300	400	1600	HNA024001	L/R	
	Tall unit 2 doors 1 glass shelf (top) 1 open compartment 1 drawer with buffered closing 2 doors 1 glass shelf	300	600	1600	HNA026001		
Central units							
	medium-high unit 1 door 1 glass shelf 2 pull-outs with buffered closing 1 top cover 325 mm deep	300	300	1136	MNA773A01	L/R	
		300	400	1136	MNA774A01	L/R	
	medium-high unit 2 doors 1 glass shelf 2 pull-outs with buffered closing 1 top cover 325 mm deep	300	600	1136	MNA776A01		

EASY LINE kera.home - model list

For further supplementary cupboards and accessories, see separate tabs

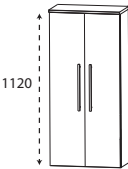
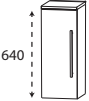
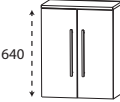
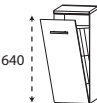
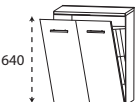
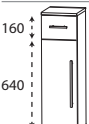
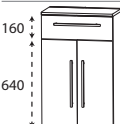
Depth indication corresponds to the carcass depth		Depth in mm	Width in mm	Height in mm	Article number	Hinge	Surcharge high-gloss carcass
Central units							
 <p>1120</p>	medium-high unit 1 door 3 glass shelves 1 top cover 325 mm deep	300	300	1136	MNA713A01	L/R	
			300	400	1136	MNA714A01	L/R
 <p>1120</p>	medium-high unit 2 doors 3 glass shelves 1 top cover 325 mm deep	300	600	1136	MNA716A01		
Highboards							
 <p>640</p>	Highboard 1 door 1 glass shelf 1 top cover 325 mm deep	300	300	656	HBA413A01	L/R	
			300	400	656	HBA414A01	L/R
 <p>640</p>	Highboard 2 doors 1 glass shelf 1 top cover 325 mm deep	300	600	656	HBA416A01		
 <p>640</p>	Highboard with laundry basket 1 laundry basket with wire basket 1 top cover 325 mm deep Volume of laundry basket: 25 liters	300	300	656	HBA413W01		
		Volume of laundry basket: 35 liters	300	400	656	HBA414W01	
 <p>640</p>	Highboard with laundry basket 1 laundry basket with wire basket 1 top cover 325 mm deep	300	600	656	HBA416W01		
	Highboard with laundry basket 1 laundry basket with wire basket Volume of laundry basket: 55 liters 1 top cover 325 mm deep						
 <p>160 640</p>	Highboard 1 drawer with buffered closing 1 door 1 glass shelf 1 top cover 325 mm deep	300	300	816	HBA553A01	L/R	
			300	400	816	HBA554A01	L/R
 <p>160 640</p>	Highboard 1 drawer with buffered closing 2 doors 1 glass shelf 1 top cover 325 mm deep	300	600	816	HBA556A01		

EASY LINE kera.home - model list

For further supplementary cupboards and accessories, see separate tabs

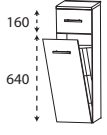
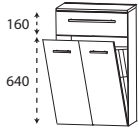
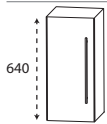
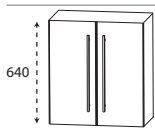
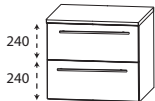
Depth indication corresponds to the carcass depth		Depth in mm	Width in mm	Height in mm	Article number	Hinge	Surcharge high-gloss carcass
Highboards							
	Highboard with laundry basket 1 drawer with buffered closing 1 laundry basket with wire basket 1 top cover 325 mm deep Volume of laundry basket: 25 liters	300	300	816	HBA 5 5 3 W 0 1		
	Volume of laundry basket: 35 liters	300	400	816	HBA 5 5 4 W 0 1		
	Highboard with laundry basket 1 drawer with buffered closing 1 laundry basket with wire basket 1 top cover 325 mm deep 1 drawer with buffered closing 1 laundry basket with wire basket Volume of laundry basket: 55 liters 1 top cover 325 mm deep	300	600	816	HBA 5 5 6 W 0 1		
Wall units							
	Wall unit 1 door 1 glass shelf	150	300	640	OGA 4 1 3 0	L/R	
		150	400	640	OGA 4 1 4 0	L/R	
	Wall unit 2 doors 1 glass shelf	150	600	640	OGA 4 1 6 0		
Base units							
	Base unit 2 pull-outs with buffered closing 1 top cover 325 mm deep	300	300	496	UNA 3 6 3 A 0 1		
		300	400	496	UNA 3 6 4 A 0 1		
		300	600	496	UNA 3 6 6 A 0 1		

SET KHOM L6

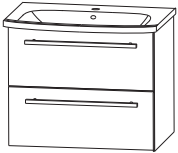
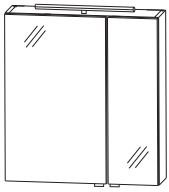

SET KHOM R6

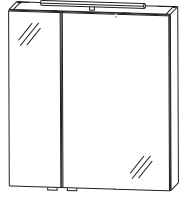

SET KHOM L8

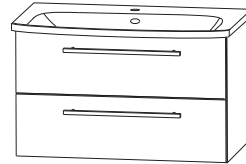
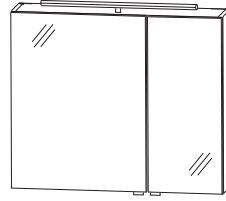

SET KHOM R8

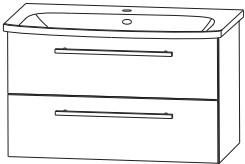
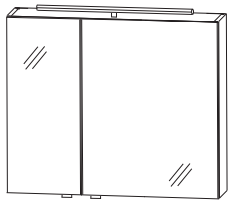

SET KHOM L9

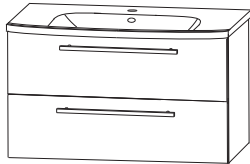
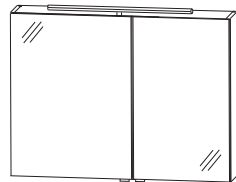

SET KHOM R9

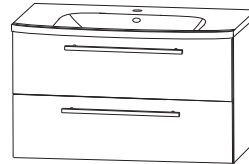
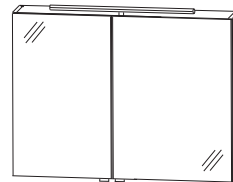

SET KHOM 12

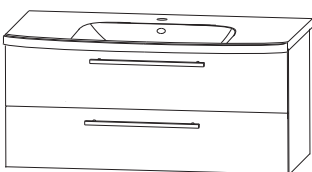
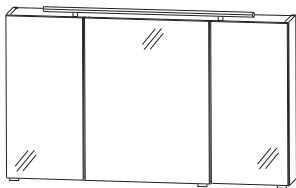

SET KHOM L5

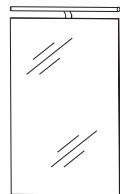

SET KHOM R5

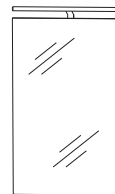

EASY LINE kera.home - dimensional drawings

WTK 7065 1

WTK 7085 1

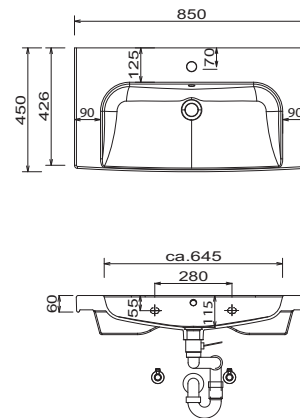
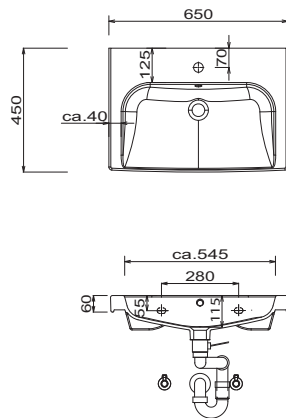

WTK 7095 1

WTK 7125 1

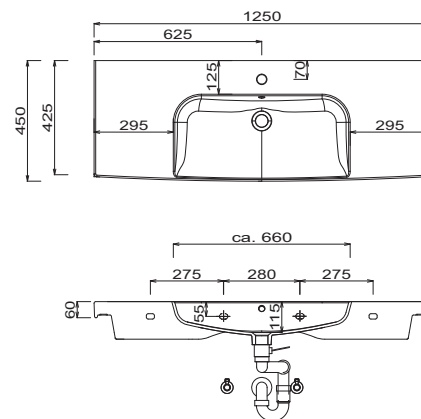
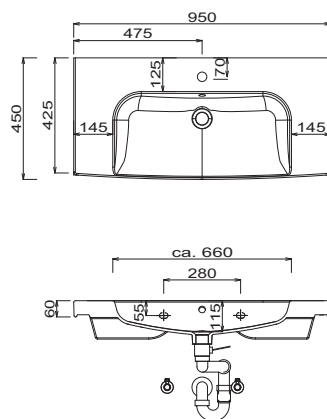

SET KH50 1

Single washbasin

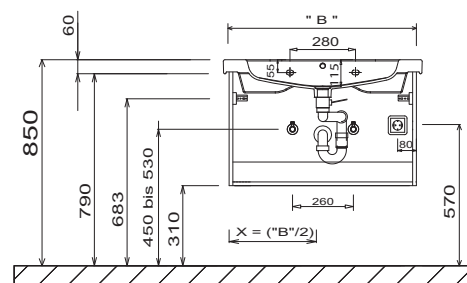
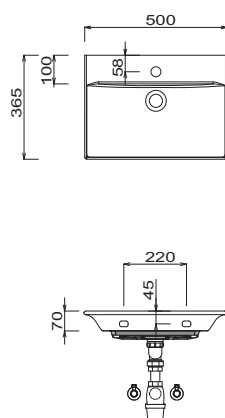

LEGEND

B = Width of Washbasin base units
X = Position wastewater connection

For washing stands with fixing screws, the dimensions for boring must be drawn in on-site after the washing stand has been laid on the floor unit.

Washing stands without anchoring brackets have to be fixed on the wall and on the furniture-side with silicon!

Modifications:

Technical modifications (+/- 5mm) and flatness modifications (DIN 18202) are subject of the usual material-specific modifications for construction materials, based on DIN 18202.

EASY LINE nera.home - dimensional drawings

GUEST BATHROOM

Mirror 400 mm

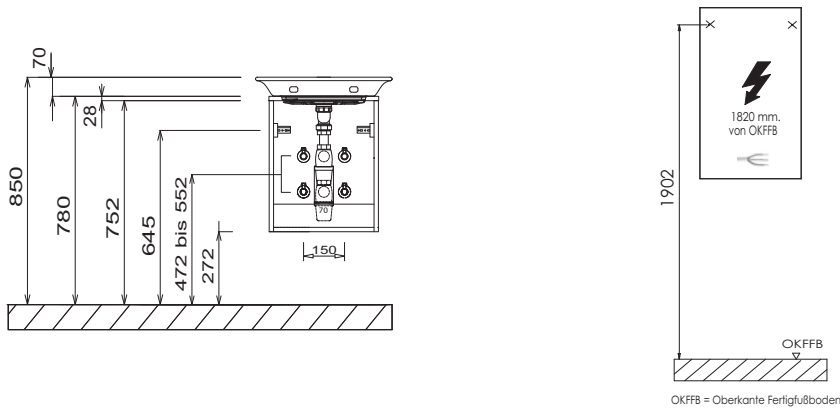

electrical connections for mirror cabinets

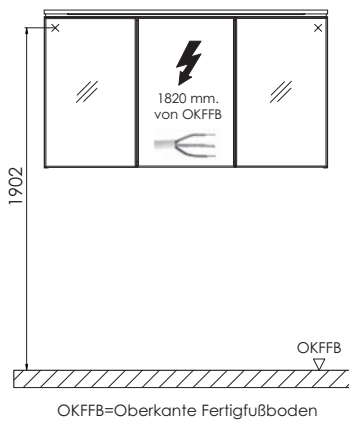

For washing stands with fixing screws, the dimensions for boring must be drawn in on-site after the washing stand has been laid on the floor unit.

Washing stands without anchoring brackets have to be fixed on the wall and on the furniture-side with silicon!

Modifications:

Technical modifications (+/- 5mm) and flatness modifications (DIN 18202) are subject of the usual material-specific modifications for construction materials, based on DIN 18202.

Kh.10

LEGEND

B = Width of Washbasin base units
X = Position wastewater connection